

For a Sustainable Future



Since 1981
Desde 1981



Yüzziak[®]
Sprinklers



Agronema
agriculture and industrial supplies



Agronema
agriculture and industrial supplies

Agronema.com



E-mail:

info@agronea.com
sales@agronea.com

Tel: +49 06048 9529830 Deutsch/English
Mobile: +49 162 9158001 Deutsch only



WP



<https://www.facebook.com/Agronema.official/>



https://www.youtube.com/channel/UCe9vRIjWGV5Fj_vLx_ihOZQ



<https://www.instagram.com/agronea.official/>

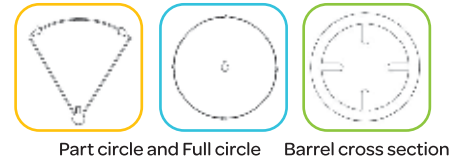

Part circle and Full circle Barrel cross section

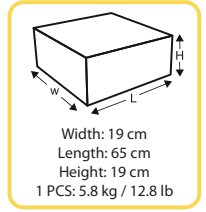

Water Input / El agua de entrada: 1,5 " Working Pressure / Presión de trabajo 2 – 6 kg/cm²
Water Requirement / Requerimientos de agua 6,5 m³/h – 32.2 m³/h
Nozzles / Boquilla 10mm – 12mm – 14mm – 16mm – 18mm
Body Angle / Cuerpo Ángulo: 28°

Meme Çapı Nozzle diameter Diámetro de la bluse Durchmesser der Hauptdüse Diámetro ugello		Basınç Pressure Pression Presión Wasserdruck im Beregner Pressione		Atış Yarı Çapı Jet Length Portée Chorro Tragweite Gittata		Su Tüketimi Capacity Débit Capacidad Kapazität Portata			Değerler bir Fıskiye içindir Values for a single sprinkler Données pour 1 arros. tout seul Datos para cada rociador Technische Daten für Einzelberegner Dati relativi ad 1 irrigatore			
									Sulanan Alan Irrigated area Surface arrosée Superficie irrigada Beregnete Fläche Superficie irrigata		Yağış Miktarı Rainfall per hour Pluviométrie horaire Intensidad horaria Wassermenge pro Stund Intensità oraria	
mm	inch	kg/cm ²	lbs/inch	m	feet	l/min	m ³ /h	G.P.M.	m ²	acre	mm/h	
10	.39	2	29	18	59	108.3	6.5	29	1018	0.25	6.4	
	.39	3	44	21	69	125	7.5	33	1384	0.34	5.4	
	.39	4	56	23	75	143.3	8.6	38	1661	0.41	5.2	
12	.47	2	29	20	66	140	8.4	37	1256	0.31	6.7	
	.47	3	44	23	75	165	9.9	44	1661	0.41	6.0	
	.47	4	56	25	82	191.7	11.5	51	1962.5	0.48	5.9	
14	.55	3	44	24	79	238.3	14.3	63	1808	0.45	7.9	
	.55	4	56	26	85	283.3	17	75	2122	0.52	8.0	
	.55	5	70	29	95	303.3	18.2	80	2640	0.65	6.9	
16	.62	3	44	28	92	303.3	18.2	80	2461	0.61	7.4	
	.62	4	56	31	102	351.7	21.1	93	3017	0.75	7.0	
	.62	5	70	33	108	391.7	23.5	103	3419	0.84	6.9	
18	.70	3	44	30	98	366.7	22	97	2826	0.70	7.8	
	.70	4	56	32	105	438.3	26.3	116	3215	0.79	8.2	
	.70	5	70	34	112	491.7	29.5	130	3630	0.90	8.1	
	.70	6	85	36	118	536.7	32.2	142	4069	1.01	7.9	

ENG

Rotatable sprinkler head with gearbox and adjustable for full or part circle coverage, featuring medium and high pressure operation operations (2,0 to 6 Bars), and high efficiency. The bestselling model of the series; changeable nozzles and dynamic water jet breaker system enable a perfect irrigation with evenly distributed water. Suitable for using in any type of delicate or rough agricultural applications; widely used especially on maize, clover, sunflower, and in nurseries. Makes full and semi-circle turns at the same speed; Ideal for agricultural areas, sport fields, and mines; suitable for portable and fixed systems.

ESP

Aspersor con cabeza giratoria de riego óptimo tipo cañón con capacidad de giro completo y en ángulo ajustable. Es la extremidad de una regadera a alta rentabilidad, con transmisión y una presión media y alta (2,0 to 6 Bar). Es el modelo más vendido de nuestra serie profesional. Garantiza una riego con una distribución regular perfecta de agua a su campo, gracias a su sistema de fractura de agua móvil y las extremidades de chorros cambiables. Se utiliza en particular generalmente para el maíz, el trébol, el girasol, y los viveros. Puede hacer rotaciones a la misma velocidad para el semicírculo y el círculo completo. Es ideal para la utilización en las zonas agrícolas, los campos de deportes y las carreras de mina. Es conveniente para los sistemas móviles y estables.

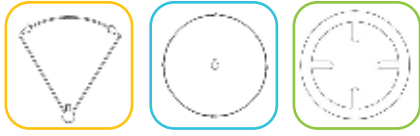

Part circle and Full circle Barrel cross section

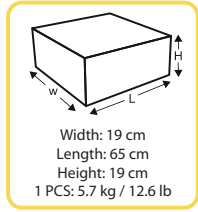

Width: 19 cm
Length: 65 cm
Height: 19 cm
1 PCS: 5.7 kg / 12.6 lb



Water Input / El agua de entrada: 1,5 "
Working Pressure / Presión de trabajo
2 – 6 kg/cm²
Water Requirement / Requerimientos de agua
6,5 m³/h – 32 m³/h
Nozzles / Boquilla
10mm – 12mm – 14mm – 16mm – 18mm
Body Angle / Cuerpo Ángulo: 24°

Meme Çapı Nozzle diameter Diamètre de la bluse Diámetro de la tobera Durchmesser der Hauptdüse Diametro ugello		Basınç Pressure Pression Presión Wasserdruck im Beregner Pressione		Atış Yarı Çapı Jet Length Portée Chorro Tragweite Gittata		Su Tüketimi Capacity Débit Capacidad Kapazitätä Portata			Değerler bir Fıskiye için Values for a single sprinkler Données pour 1 arros. tout seul Datos para cada rociador Technische Daten für Einzelberegner Dati relativi ad 1 irrigatore			
									Sulanan Alan Irrigated area Surface arrosée Superficie irrigada Beregnete Fläche Superficie irrigata		Yağış Miktarı Rainfall per hour Pluviométrie horaire Intensidad horaira Wassermenge pro Stund Intensità oraria	
mm	inch	kg/cm ²	lbs/inch	m	feet	l/min	m ³ /h	G.P.M.	m ²	acre	mm/h	
10	.39	2	29	18	59	108.3	6.5	29	1018	0.25	6.4	
	.39	3	44	21	69	125	7.5	33	1384	0.34	5.4	
	.39	4	56	23	75	143.3	8.6	38	1661	0.41	5.2	
12	.47	2	29	20	66	140	8.4	37	1256	0.31	6.7	
	.47	3	44	23	75	165	9.9	44	1661	0.41	6.0	
	.47	4	56	25	82	191.7	11.5	51	1962.5	0.48	5.9	
14	.55	3	44	24	79	238.3	14.3	63	1808	0.45	7.9	
	.55	4	56	26	85	283.3	17	75	2122	0.52	8.0	
	.55	5	70	29	95	303.3	18.2	80	2640	0.65	6.9	
16	.62	3	44	28	92	303.3	18.2	80	2461	0.61	7.4	
	.62	4	56	31	102	351.7	21.1	93	3017	0.75	7.0	
	.62	5	70	33	108	391.7	23.5	103	3419	0.84	6.9	
18	.70	3	44	30	98	366.7	22	97	2826	0.70	7.8	
	.70	4	56	32	105	438.3	26.3	116	3215	0.79	8.2	
	.70	5	70	34	112	491.7	29.5	130	3630	0.90	8.1	
	.70	6	85	36	118	536.7	32.2	142	4069	1.01	7.9	

ENG

Rotatable sprinkler head with gearbox and adjustable for full or part circle coverage, featuring medium and high pressure operation operations (2,0 to 6 Bars), and high efficiency. The bestselling model of the series; changeable nozzles and dynamic water jet breaker system enable a perfect irrigation with evenly distributed water. Suitable for using in any type of delicate or rough agricultural applications; widely used especially on maize, clover, sunflower, and in nurseries. Makes full and semi-circle turns at the same speed; Ideal for agricultural areas, sport fields, and mines; suitable for portable and fixed systems.

ESP

Aspersor con cabeza giratoria de riego óptimo tipo cañón con capacidad de giro completo y en ángulo ajustable. Es la extremidad de una regadera a alta rentabilidad, con transmisión y una presión media y alta (2,0 to 6 Bar). Es el modelo más vendido de nuestra serie profesional. Garantiza un riego con una distribución regular perfecta de agua a su campo, gracias a su sistema de fractura de agua móvil y las extremidades de chorros cambiables. Se utiliza en particular generalmente para el maíz, el trébol, el girasol, y los viveros. Puede hacer rotaciones a la misma velocidad para el semicírculo y el círculo completo. Es ideal para la utilización en las zonas agrícolas, los campos de deportes y las carreras de mina. Es conveniente para los sistemas móviles y estables.

Yüziak® Sprinklers



Part circle and Full circle Barrel cross section

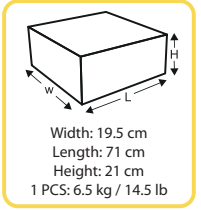

Water Input / El agua de entrada: 2"
Working Pressure / Presión de trabajo
2 – 6 kg/cm²
Water Requirement / Requerimientos de agua
9 m³/h – 44 m³/h
Nozzles / Boquilla
10mm – 12mm – 14mm – 16mm – 18mm – 20mm – 22mm
Body Angle / Cuerpo Ángulo: 25°

Meme Çapı Nozzle diameter Diamètre de la bluse Diámetro de la tobera Durchmesser der Hauptdüse Diámetro ugello		Basınc Pressure Pression Presión Wasserdruck im Beregnr Pressione		Atış Yarı Çapı Jet Length Portée Chorro Tragweite Gittata		Su Tüketimi Capacity Débit Capacidad Kapazität Portata			Değerler bir Fıskiye içindir Values for a single sprinkler Données pour 1 arros. tout seul Datos para cada rociador Technische Daten für Einzelberegnr Dati relativi ad 1 irrigatore			
mm	inch	kg/cm ²	lbs/inch	m	feet	l/min	m ³ /h	G.P.M.	Sulanan Alan Irrigated area Surface arrosée Superficie irrigada Beregnete Fläche Superficie irrigata		Yağış Miktarı Rainfall per hour Pluviométrie horaire Intensidad horaira Wassermenge pro Stund Intensità oraria	
									m ²	acre	mm/h	mm/h
12	.47	2	29	24	79	140	8,4	37	1384	0,34	6,1	
	.47	3	44	29	95	165	9,9	44	1962	0,48	5,0	
	.47	4	56	31	102	191,7	11,5	51	2461	0,61	4,7	
14	.55	3	44	30	98	238,3	14,3	63	2461	0,61	5,8	
	.55	4	56	31	102	283,3	17	75	2826	0,70	6,0	
	.55	5	70	35	115	303,3	18,2	80	3215	0,79	5,7	
16	.62	3	44	32	105	303,3	18,2	80	2826	0,70	6,4	
	.62	4	56	35	115	351,7	21,1	93	3419	0,84	6,2	
	.62	5	70	38	125	391,7	23,5	103	3846	0,95	6,1	
18	.70	3	44	33	108	366,7	22	97	3017	0,75	7,3	
	.70	4	56	36	118	438,3	26,3	116	3630	0,90	7,2	
	.70	5	70	40	131	491,7	29,5	130	4298	1,06	6,9	
20	.78	3	44	35	115	450	27	119	3630	0,90	7,4	
	.78	4	56	39	128	525	31,5	139	4298	1,06	7,3	
	.78	5	70	43	141	600	36	159	5024	1,24	7,2	
22	.86	4	44	40	131	633,3	38	167	4298	1,06	8,8	
	.86	5	56	44	144	700	42	185	5024	1,24	8,4	
	.86	6	85	45	148	733,3	44	194	5805	1,43	7,6	

ENG

Rotatable sprinkler head with gearbox and adjustable for full or part circle coverage, featuring medium and high pressure operation operations (2,0 to 6 Bars), and high efficiency . The bestselling model of the series; changeable nozzles and dynamic water jet breaker system enable a perfect irrigation with evenly distributed water. Suitable for using in any type of delicate or rough agricultural applications; widely used especially on maize, clover, sunflower, and in nurseries. Makes full and semi-circle turns at the same speed; Ideal for agricultural areas, sport fields, and mines; suitable for portable and fixed systems.

ESP

Aspersor con cabeza giratoria de riego óptimo tipo cañón con capacidad de giro completo y en ángulo ajustable. Es la extremidad de una regadera a alta rentabilidad, con transmisión y una presión media y alta (2,0 to 6 Bar). Es el modelo más vendido de nuestra serie profesional. Garantiza una riego con una distribución regular perfecta de agua a su campo, gracias a su sistema de fractura de agua móvil y las extremidades de chorros cambiabiles. Se utiliza en particular generalmente para el maíz, el trébol, el girasol, y los viveros. Puede hacer rotaciones a la misma velocidad para el semicírculo y el círculo completo. Es ideal para la utilización en las zonas agrícolas, los campos de deportes y las carreras de mina. Es conveniente para los sistemas móviles y estables.

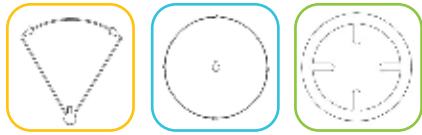

Part circle and Full circle Barrel cross section

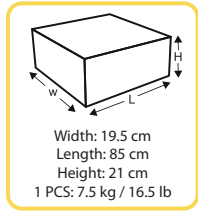

Yüzüak®
Sprinklers



CIT* tested	Jet 50	80 x 80mm
	CU In %	89
	DU In %	85

*Center of Irrigation Technologies
Fresno, California/USA

† Needs 90psi 200psi @ bar



Water Input / El agua de entrada: 2"
Working Pressure / Presión de trabajo
2 – 6 kg/cm²
Water Requirement / Requerimientos de agua
14,0 m³/h – 61 m³/h
Nozzles / Boquilla
14mm – 16mm – 18mm – 20mm – 22mm – 24mm
Body Angle / Cuerpo Ángulo: 25°

Meme Çapı Nozzle diameter Diámetro de la bluse Durchmesser der Hauptdüse Diámetro ugello		Basınç Pressure Pression Presión Wasserdruck im Beregnern Pressione		Atış Yarı Çapı Jet Length Portée Chorro Tragweite Gittata		Su Tüketimi Capacity Débit Capacidad Kapazität Portata			Değerler bir Fıskiye için Values for a single sprinkler Données pour 1 arros. tout seul Datos para cada rociador Technische Daten für Einzelberegner Dati relativi ad 1 irrigatore		
mm	inch	kg/cm ²	lbs/inch	m	feet	l/min	m ³ /h	G.P.M.	Sulanan Alan Irrigated area Surface arrosée Superficie irrigada Beregnete Fläche Superficie irrigata		Yağış Miktarı Rainfall per hour Pluviométrie horaire Intensidad horaria Wassermenge pro Stund Intensità oraria
									m ²	acre	mm/h
14	.55	3	44	29	95	246,7	14,8	65	2640	0,65	5,6
	.55	4	56	32	105	286,7	17,2	76	3215	0,79	5,3
	.55	5	70	34	112	315	18,9	83	3629	0,90	5,2
16	.62	3	44	30	98	308,3	18,5	81	2826	0,70	6,5
	.62	4	56	34	112	358,3	21,5	95	3629	0,90	5,9
	.62	5	70	35	115	391,7	23,5	103	3846	0,95	6,1
18	.70	3	44	32	105	390	23,4	103	3215	0,79	7,3
	.70	4	56	35	115	445	26,7	118	3846	0,95	6,9
	.70	5	70	38	125	498,3	29,9	132	4534	1,12	6,6
20	.78	3	44	35	115	463,3	27,8	122	3846	0,95	7,2
	.78	4	56	38	125	548,3	32,9	145	4534	1,12	7,3
	.78	5	70	42	138	616,7	37	163	5538	1,37	6,7
22	.86	4	56	40	131	680	40,8	180	5024	1,24	8,1
	.86	5	70	44	144	753,3	45,2	199	6079	1,50	7,4
	.86	6	85	47	154	818,3	49,1	216	6936	1,71	7,1
24	.94	5	70	46	151	886,7	53,2	234	6644	1,64	8,0
	.94	6	85	48	157	958,3	57,5	253	7234	1,79	7,9
	.94	7	100	50	164	1020	61,2	269	7850	1,94	7,8

ENG

Rotatable sprinkler head with gearbox and adjustable for full or part circle coverage, featuring medium and high pressure operation operations (3,0 to 7 Bars), and high efficiency. The bestselling model of the series; changeable nozzles and dynamic water jet breaker system enable a perfect irrigation with evenly distributed water. Suitable for using in any type of delicate or rough agricultural applications; widely used especially on maize, clover, sunflower, and in nurseries. Makes full and semi-circle turns at the same speed; Ideal for agricultural areas, sport fields, and mines; suitable for portable and fixed systems.

ESP

Aspersor con cabeza giratoria de riego óptimo tipo cañón con capacidad de giro completo y en ángulo ajustable. Es la extremidad de una regadera a alta rentabilidad, con transmisión y una presión media y alta (3,0 to 7 Bar). Es el modelo más vendido de nuestra serie profesional. Garantiza una riego con una distribución regular perfecta de agua a su campo, gracias a su sistema de fractura de agua móvil y las extremidades de chorros cambiables. Se utiliza en particular generalmente para el maíz, el trébol, el girasol, y los viveros. Puede hacer rotaciones a la misma velocidad para el semicírculo y el círculo completo. Es ideal para la utilización en las zonas agrícolas, los campos de deportes y las carreras de mina. Es conveniente para los sistemas móviles y estables.



Part circle and Full circle Barrel cross section

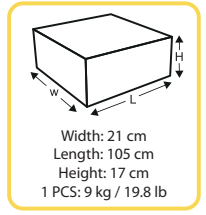

Water Input / El agua de entrada: 2,5"
Working Pressure / Presión de trabajo
3 – 6 kg/cm²
Water Requirement / Requerimientos de agua
28 m³/h – 82 m³/h
Nozzles / Boquilla
20mm – 22mm – 24mm – 26mm – 28mm
Body Angle / Cuerpo Ángulo: 25°

Meme Çapı Nozzle diameter Diámetro de la tobera Durchmesser der Hauptdüse Diámetro ugello		Basınç Pressure Pression Presión Wasserdruck im Beregner Pressione		Atış Yarı Çapı Jet Length Portée Chorro Tragweite Gittata		Su Tüketimi Capacity Débit Capacidad Kapazität Portata			Değerler bir Fıskiye içindir Values for a single sprinkler Données pour 1 arros. tout seul Datos para cada rociador Technische Daten für Einzelberegne Dati relativi ad 1 irrigatore			
									Sulanan Alan Irrigated area Surface arrosée Superficie irrigada Beregnete Fläche Superficie irrigata		Yağış Miktarı Rainfall per hour Pluviométrie horaire Intensidad horaira Wassermenge pro Stund Intensità oraria	
mm	inch	kg/cm ²	lbs/inch	m	feet	l/min	m ³ /h	G.P.M.	m ²	acre	mm/h	
20	.78	3	44	35	115	463,3	28	122	3846	0,95	7,2	
	.78	4	56	38	125	548,3	33	145	4534	1,12	7,3	
	.78	5	70	42	138	616,7	37	163	5538	1,37	6,7	
22	.86	4	56	40	131	680,0	41	180	5024	1,24	8,1	
	.86	5	70	44	144	753,3	45	199	6079	1,50	7,4	
	.86	6	85	47	154	818,3	49	216	6936	1,71	7,1	
24	.94	5	70	46	151	886,7	53	234	6644	1,64	8,0	
	.94	6	85	48	157	958,3	58	253	7234	1,79	7,9	
	.94	7	100	50	164	1020,0	61	269	7850	1,94	7,8	
26	1	4	56	45	148	866,7	52	229	6358	1,57	8,2	
	1	5	70	48	157	966,7	58	255	7234	1,79	8,0	
	1	6	85	51	167	1066,7	64	282	8167	2,02	7,8	
28	1.1	5	70	50	164	1116,7	67	295	7850	1,94	8,5	
	1.1	6	85	53	174	1233,3	74	326	8820	2,18	8,4	
	1.1	7	100	55	180	1358,3	82	359	9498	2,35	8,6	

ENG Rotatable sprinkler head with gearbox and adjustable for full or part circle coverage, featuring medium and high pressure operation operations (3,0 to 7 Bars), and high efficiency. The bestselling model of the series; changeable nozzles and dynamic water jet breaker system enable a perfect irrigation with evenly distributed water. Suitable for using in any type of delicate or rough agricultural applications; widely used especially on maize, clover, sunflower, and in nurseries. Makes full and semi-circle turns at the same speed; Ideal for agricultural areas, sport fields, and mines; suitable for portable and fixed systems.

ESP Aspersor con cabeza giratoria de riego óptimo tipo cañón con capacidad de giro completo y en ángulo ajustable. Es la extremidad de una regadera a alta rentabilidad, con transmisión y una presión media y alta (3,0 to 7 Bar). Es el modelo más vendido de nuestra serie profesional. Garantiza una riego con una distribución regular perfecta de agua a su campo, gracias a su sistema de fractura de agua móvil y las extremidades de chorros cambiables. Se utiliza en particular generalmente para el maíz, el trébol, el girasol, y los viveros. Puede hacer rotaciones a la misma velocidad para el semicírculo y el círculo completo. Es ideal para la utilización en las zonas agrícolas, los campos de deportes y las carreras de mina. Es conveniente para los sistemas móviles y estables.

Yüziak® Sprinklers

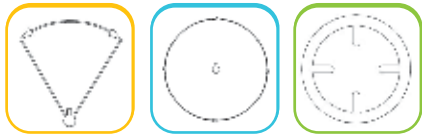

Part circle and Full circle Barrel cross section

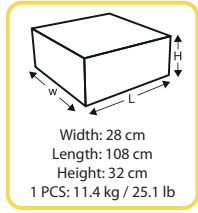

CIT* tested	Jet 65	68 x 72mm
	CU In %	87
	DU In %	78

*Center of Irrigation Technologies
Fresno, California/USA
†Nominal Max. Static 8 bar



Water Input / El agua de entrada : Flange 130mm x 78mm
Working Pressure / Presión de trabajo
3 – 7 kg/cm²
Water Requirement / Requerimientos de agua
30 m³/h – 108 m³/h
Nozzles / Boquilla
20mm – 22mm – 24mm – 26mm – 28mm – 30mm – 32mm
Body Angle / Cuerpo Ángulo: 25°

Meme Çapı Nozzle diameter Diamètre de la buse Diámetro de la tobera Durchmesser der Hauptdüse Diametro ugello		Basınç Pressure Pression Presión Wasserdruck im Beregnr Pressione		Atış Yarı Çapı Jet Length Portée Chorro Tragweite Gittata		Su Tüketimi Capacity Débit Capacidad Kapazität Portata			Değerler bir Fıskiye içindir Values for a single sprinkler Données pour 1 arros. tout seul Datos para cada rociador Technische Daten für Einzelberegnr Dati relativi ad 1 irrigatore		
mm	inch	kg/cm ²	lbs/inch	m	feet	l/min	m ³ /h	G.P.M.	Fläche Superficie irrigata	acre	mm/h
20	0,78	3	44	35	115	500,0	30	132	3847	0,95	7,8
	0,78	4	56	39	128	583,3	35	154	4776	1,18	7,3
	0,78	5	70	43	141	650,0	39	172	5806	1,43	6,7
22	0,86	3	44	37	121	600,0	36	159	4299	1,06	8,4
	0,86	4	56	41	134	683,3	41	181	5278	1,30	7,8
	0,86	5	70	47	154	766,7	46	203	6936	1,71	6,6
24	0,86	6	85	48	157	833,3	50	220	7234	1,79	6,9
	0,94	4	56	43	141	730	48	211	5806	1,43	8,3
	0,94	5	70	49	161	917	55	242	7539	1,86	7,3
26	0,94	6	85	52	171	983	59	260	8491	2,10	6,9
	1,1	4	56	48	157	933	56	247	7235	1,79	7,7
	1,1	5	70	50	164	1050	63	277	7850	1,94	8,0
28	1,1	6	85	53	174	1133	68	299	8820	2,18	7,7
	1,1	4	56	49	161	1083	65	286	7539	1,86	8,6
	1,1	5	70	53	174	1200	72	317	8820	2,18	8,2
30	1,1	6	85	56	184	1300	78	343	9847	2,43	7,9
	1,18	5	70	55	180	1350	81	357	9499	2,35	8,5
	1,18	6	85	57	187	1483	89	392	10202	2,52	8,7
32	1,18	7	100	62	203	1600	96	423	12070	2,98	8,0
	1,25	5	70	56	184	1533	92	405	9847	2,43	9,3
	1,25	6	85	60	197	1667	100	440	11304	2,79	8,8
	1,25	7	100	63	207	1800	108	476	12463	3,08	8,7

ENG Rotatable sprinkler head with gearbox and adjustable for full or part circle coverage, featuring medium and high pressure operation operations (3,0 to 7 Bars), and high efficiency . The bestselling model of the series; changeable nozzles and dynamic water jet breaker system enable a perfect irrigation with evenly distributed water. Suitable for using in any type of delicate or rough agricultural applications; widely used especially on maize, clover, sunflower, and in nurseries. Makes full and semi-circle turns at the same speed; Ideal for agricultural areas, sport fields, and mines; suitable for portable and fixed systems.

ESP Aspersor con cabeza giratoria de riego óptimo tipo cañon con capacidad de giro completo y en ángulo ajustable. Es la extremidad de una regadera a alta rentabilidad, con transmisión y una presión media y alta (3,0 to 7 Bar). Es el modelo más vendido de nuestra serie profesional. Garantiza un riego con una distribución regular perfecta de agua a su campo, gracias a su sistema de fractura de agua móvil y las extremidades de chorros cambiables. Se utiliza en particular generalmente para el maíz, el trébol, el girasol, y los viveros. Puede hacer rotaciones a la misma velocidad para el semicírculo y el círculo completo. Es ideal para la utilización en las zonas agrícolas, los campos de deportes y las carreras de mina. Es conveniente para los sistemas móviles y estables.

Yüziak® Sprinklers

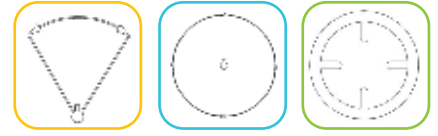

Part circle and Full circle Barrel cross section

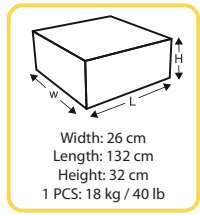

Water Input / El agua de entrada : Flange 145mm x 78mm
 Working Pressure / Presión de trabajo
 4 – 9 kg/cm²
 Water Requirement / Requerimientos de agua
 63 m³/h – 201 m³/h
 Nozzles / Boquilla
 30mm – 32mm – 34mm – 36mm
 Body Angle / Cuerpo Ángulo: 23°

Meme Çapı Nozzle diameter Diámetro de la tobera Durchmesser der Hauptdüse Diámetro ugello	Basınç Pressure Pression Wasserdruck im Beregner Pressione		Atış Yarı Çapı Jet Length Portée Chorro Tragweite Gittata		Su Tüketimi Capacity Débit Capacidad Kapazität Portata			Değerler bir Fıskiye için dir Values for a single sprinkler Données pour 1 arros. tout seul Datos para cada rociador Technische Daten für Einzelberegner Dati relativi ad 1 irrigatore			
	inch	kg/cm ²	lbs/inch	m	feet	l/min	m ³ /h	G.P.M.	Sulanan Alan Irrigated area Surface arrosée Superficie irrigada Beregnete Fläche Superficie irrigata	Yağış Miktarı Rainfall per hour Pluviométrie horaire Intensidad horaria Wassermenge pro Stund Intensità oraria	
28	1,1	4	56	50	164	1050	63	277	7850	1,94	8,0
	1,1	5	70	54	177	1200	72	317	9156	2,26	7,9
	1,18	6	85	58	190	1300	78	343	10563	2,61	7,4
30	1,18	4	56	52	171	1220	73,2	322	8491	2,10	8,6
	1,18	5	70	55	180	1383	83	365	9499	2,35	8,7
	1,18	6	85	60	197	1488	89,3	393	11304	2,79	7,9
32	1,25	4	56	54	177	1383	83	365	9156	2,26	9,1
	1,25	5	70	58	190	1550	93	409	10563	2,61	8,8
	1,25	6	85	63	207	1733	104	458	12463	3,08	8,3
34	1,25	7	100	66	216	1850	111	489	13678	3,38	8,1
	1,33	5	70	59	194	1750	105	462	10930	2,70	9,6
	1,33	6	85	63	207	1950	117	515	12463	3,08	9,4
36	1,33	7	100	68	223	2033	122	537	14519	3,59	8,4
	1,42	6	85	66	216	2117	127	559	13678	3,38	9,3
	1,42	7	100	70	230	2253	135	595	15386	3,80	8,8
38	1,42	8	114	74	243	2435	146	643	17195	4,25	8,5
	1,5	6	85	67	220	2317	139	612	14095	3,48	9,9
	1,5	7	100	71	233	2483	149	656	15829	3,91	9,4
40	1,5	8	114	75	246	2683	161	709	17663	4,36	9,1
	1,57	6	85	68	223	2600	156	687	14519	3,59	10,7
	1,57	7	100	73	239	2700	162	713	16733	4,13	9,7
42	1,57	8	114	76	249	2950	177	779	18137	4,48	9,8
	1,65	6	85	70	230	2800	168	740	15386	3,80	10,9
	1,65	7	100	74	243	3000	180	793	17195	4,25	10,5
	1,65	8	114	79	259	3150	189	832	19597	4,84	9,6

ENG

Rotatable sprinkler head with gearbox and adjustable for full or part circle coverage, featuring medium and high pressure operation operations (3,0 to 8 Bars), and high efficiency. The bestselling model of the series; changeable nozzles and dynamic water jet breaker system enable a perfect irrigation with evenly distributed water. Suitable for using in any type of delicate or rough agricultural applications; widely used especially on maize, clover, sunflower, and in nurseries. Makes full and semi-circle turns at the same speed; Ideal for agricultural areas, sport fields, and mines; suitable for portable and fixed systems.

ESP

Aspersor con cabeza giratoria de riego óptimo tipo cañón con capacidad de giro completo y en ángulo ajustable. Es la extremidad de una regadera a alta rentabilidad, con transmisión y una presión media y alta (3,0 to 8 Bar). Es el modelo más vendido de nuestra serie profesional. Garantiza un riego con una distribución regular perfecta de agua a su campo, gracias a su sistema de fractura de agua móvil y las extremidades de chorros cambiables. Se utiliza en particular generalmente para el maíz, el trébol, el girasol, y los viveros. Puede hacer rotaciones a la misma velocidad para el semicírculo y el círculo completo. Es ideal para la utilización en las zonas agrícolas, los campos de deportes y las carreras de mina. Es conveniente para los sistemas móviles y estables.

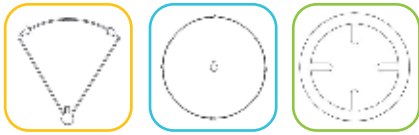

Part circle and Full circle Barrel cross section

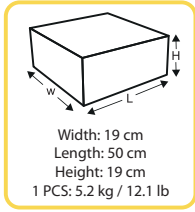

Water Input / El agua de entrada: 2"
Working Pressure / Presión de trabajo
2 – 6 kg/cm²
Water Requirement / Requerimientos de agua
6,5 m³/h – 48 m³/h
Nozzles / Boquilla
10mm – 12mm – 14mm – 16mm – 18mm – 20mm – 22mm
Body Angle / Cuerpo Ángulo: 25°

Meme Çapı Nozzle diameter Diamètre de la bluse Diámetro de la tobera Durchmesser der Hauptdüse Diámetro ugello		Basınç Pressure Pression Presión Wasserdruck im Beregnere Pressione		Atış Yarı Çapı Jet Length Portée Chorro Tragweite Gittata		Su Tüketimi Capacity Débit Capacidad Kapazität Portata			Değerler bir Fiskeye içindir Values for a single sprinkler Données pour 1 arros. tout seul Datos para cada rociador Technische Daten für Einzelberegnere Dati relativi ad 1 irrigatore		
mm	inch	kg/cm ²	lbs/inch	m	feet	l/min	m ³ /h	G.P.M.	Sulanan Alan Irrigated area Surface arrosée Superficie irrigada Beregnere Fläche Superficie irrigata		Yağış Miktarı Rainfall per hour Pluviométrie horaire Intensidad horaria Wassermenge pro Stund Intensità oraria
									m ²	acre	mm/h
10	.39	2	29	19	62	108.3	6.5	29	1133.54	0.28	5.7
	.39	3	44	21	69	125	7.5	33	1384	0.34	5.4
	.39	4	56	23	75	143.3	8.6	38	1661	0.41	5.2
12	.47	2	29	21	69	140	8.4	37	1384	0.34	6.1
	.47	3	44	25	82	165	9.9	44	1962	0.48	5.0
	.47	4	56	28	92	191.7	11.5	51	2461	0.61	4.7
14	.70	3	44	28	92	238.3	14.3	63	2461	0.61	5.8
	.70	4	56	30	98	283.3	17	75	2826	0.70	6.0
	.70	5	70	32	105	303.3	18.2	80	3215	0.79	5.7
16	.62	3	44	30	98	303.3	18.2	80	2826	0.70	6.4
	.62	4	56	33	108	351.7	21.1	93	3419	0.84	6.2
	.62	5	70	35	115	391.7	23.5	103	3846	0.95	6.1
18	.70	3	44	31	102	366.7	22	97	3017	0.75	7.3
	.70	4	56	34	112	438.3	26.3	116	3630	0.90	7.2
	.70	5	70	37	121	491.7	29.5	130	4298	1.06	6.9
20	.78	3	44	34	112	450	27	119	3630	0.90	7.4
	.78	4	56	37	121	525	31.5	139	4298	1.06	7.3
	.78	5	70	40	131	600	36	159	5024	1.24	7.2
22	.86	4	56	37	121	633.3	38	167	4298	1.06	8.8
	.86	5	70	40	131	700	42	185	5024	1.24	8.4
	.86	6	85	43	141	733.3	44	194	5805	1.43	7.6
	.86	7	100	46	151	808.3	48.5	214	6644	1.64	7.3

ENG

Rotatable sprinkler head with gearbox and adjustable for full or part circle coverage, featuring medium and high pressure operation operations (2,0 to 7 Bars), and high efficiency. The bestselling model of the series; changeable nozzles and dynamic water jet breaker system enable a perfect irrigation with evenly distributed water. Suitable for using in any type of delicate or rough agricultural applications; widely used especially on maize, clover, sunflower, and in nurseries. Makes full and semi-circle turns at the same speed; Ideal for agricultural areas, sport fields, and mines; suitable for portable and fixed systems.

ESP

Aspersor con cabeza giratoria de riego óptimo tipo cañón con capacidad de giro completo y en ángulo ajustable. Es la extremidad de una regadera a alta rentabilidad, con transmisión y una presión media y alta (2,0 to 7 Bar). Es el modelo más vendido de nuestra serie profesional. Garantiza una riego con una distribución regular perfecta de agua a su campo, gracias a su sistema de fractura de agua móvil y las extremidades de chorros cambiables. Se utiliza en particular generalmente para el maíz, el trébol, el girasol, y los viveros. Puede hacer rotaciones a la misma velocidad para el semicírculo y el círculo completo. Es ideal para la utilización en las zonas agrícolas, los campos de deportes y las carreras de mina. Es conveniente para los sistemas móviles y estables.

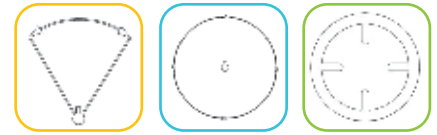

Part circle and Full circle Barrel cross section

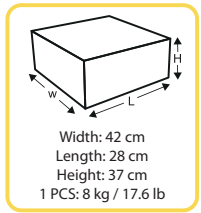

Water Input / El agua de entrada: 2"
Working Pressure / Presión de trabajo
3 – 7 kg/cm²
Water Requirement / Requerimientos de agua
30 m³/h – 108 m³/h
Nozzles / Boquilla
20mm – 22mm – 24mm – 26mm – 28mm – 30mm – 32mm
Body Angle / Cuerpo Ángulo: 25°

Meme Çapı Nozzle diameter Diamètre de la bluse Diámetro de la tobera Durchmesser der Hauptdüse Diámetro ugello		Basınç Pressure Pression Presión Wasserdruck im Beregnen Pressione		Atış Yarı Çapı Jet Length Portée Chorro Tragweite Gittata		Su Tüketimi Capacity Débit Capacidad Kapazität Portata			Değerler bir Fıskiye için Values for a single sprinkler Données pour 1 arros. tout seul Datos para cada rociador Technische Daten für Einzelberegner Dati relativi ad 1 irrigatore		
mm	inch	kg/cm ²	lbs/inch	m	feet	l/min	m ³ /h	G.P.M.	Sulanan Alan Irrigated area Surface arrosée Superficie irrigada Beregnete Fläche Superficie irrigata	Yağış Miktarı Rainfall per hour Pluviométrie horaire Intensidad horaria Wassermenge pro Stund Intensità oraria	
									m ²	acre	mm/h
20	0.78	3	44	34	112	500.0	30	132	3630	0.90	8.3
	0.78	4	56	38	125	583.3	35	154	4534	1.12	7.7
	0.78	5	70	41	134	650.0	39	172	5278	1.30	7.4
22	0.86	3	44	36	118	600.0	36	159	4069	1.01	8.8
	0.86	4	56	40	131	683.3	41	181	5024	1.24	8.2
	0.86	5	70	45	148	766.7	46	203	6359	1.57	7.2
24	0.86	6	85	47	154	833.3	50	220	6936.26	1.71	7.2
	0.94	4	44	41	134	730	48	211	5278	1.30	9.1
	0.94	5	56	48	157	916.7	55	242	7235	1.79	7.6
26	0.94	6	70	50	164	983.3	59	260	7850	1.94	7.5
	1.02	4	56	46	151	933.3	56	247	6644	1.64	8.4
	1.02	5	70	48	157	1050	63	277	7235	1.79	8.7
28	1.02	6	85	51	167	1133	68	299	8167	2.02	8.3
	1.1	4	56	47	154	1083	65	286	6936	1.71	9.4
	1.1	5	70	51	167	1200	72	317	8167	2.02	8.8
30	1.1	6	85	55	180	1300	78	343	9499	2.35	8.2
	1.18	5	70	53	174	1350	81	357	8820	2.18	9.2
	1.18	6	85	54	177	1483	89	392	9156	2.26	9.7
32	1.18	7	100	60	197	1600	96	423	11304	2.79	8.5
	1.25	5	70	54	177	1533	92	405	9156	2.26	10.0
	1.25	6	85	58	190	1667	100	440	10563	2.61	9.5
	1.25	7	100	61	200	1800	108	476	11684	2.89	9.2

ENG

Rotatable sprinkler head with gearbox and adjustable for full or part circle coverage, featuring medium and high pressure operation operations (2,0 to 7 Bars), and high efficiency. The bestselling model of the series; changeable nozzles and dynamic water jet breaker system enable a perfect irrigation with evenly distributed water. Suitable for using in any type of delicate or rough agricultural applications; widely used especially on maize, clover, sunflower, and in nurseries. Makes full and semi-circle turns at the same speed; Ideal for agricultural areas, sport fields, and mines; suitable for portable and fixed systems.

ESP

Aspersor con cabeza giratoria de riego óptimo tipo cañón con capacidad de giro completo y en ángulo ajustable. Es la extremidad de una regadera a alta rentabilidad, con transmisión y una presión media y alta (2,0 to 7 Bar). Es el modelo más vendido de nuestra serie profesional. Garantiza una riego con una distribución regular perfecta de agua a su campo, gracias a su sistema de fractura de agua móvil y las extremidades de chorros cambiables. Se utiliza en particular generalmente para el maíz, el trébol, el girasol, y los viveros. Puede hacer rotaciones a la misma velocidad para el semicírculo y el círculo completo. Es ideal para la utilización en las zonas agrícolas, los campos de deportes y las carreras de mina. Es conveniente para los sistemas móviles y estables.

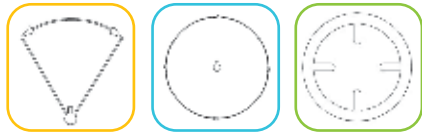

Part circle and Full circle Barrel cross section

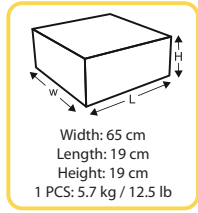

Width: 65 cm
Length: 19 cm
Height: 19 cm
1 PCS: 5.7 kg / 12.5 lb

Yüziak®
Sprinklers



Water Input / El agua de entrada: 1.5" Working Pressure / Presión de trabajo 1.75 - 5 kg/cm²
Water Requirement / Requerimientos de agua 7 m³/h - 28 m³/h
Nozzles / Boquilla 12mm - 14mm - 16mm - 18mm
Body Angle / Cuerpo Ángulo: 18°

Meme Çapı Nozzle diameter Diamètre de la bluse Diámetro de la tobera Durchmesser der Hauptdüse Diámetro ugello		Basınç Pressure Pression Presión Wasserdruck im Beregnen Pressione		Atış Yarı Çapı Jet Length Portée Chorro Tragweite Gittata		Su Tüketimi Capacity Débit Capacidad Kapazität Portata		Değerler bir Fıskiye içindir Values for a single sprinkler Données pour 1 arros. tout seul Datos para cada rociador Technische Daten für Einzelberegner Dati relativi ad 1 irrigatore			
mm	inch	kg/cm ²	lbs/inch	m	feet	l/min	m ³ /h	G.P.M.	Sulanan Alan Irrigated area Surface arrosée Superficie irrigada Beregnete Fläche Superficie irrigata		Yağış Miktarı Rainfall per hour Pluviométrie horaire Intensidad horaria Wassermenge pro Stunde Intensità oraria
									m ²	acre	mm/h
12	.47	1,75	25	17	54	117	7	31	855	0,21	8,2
	.47	2	29	19	61	133	8	35	1075	0,27	7,4
	.47	2,5	37	20	66	162	9,7	43	1256	0,31	7,7
	.47	3	44	22	71	177	10,6	47	1451	0,36	7,3
	.47	4	56	24	77	203	12,2	54	1734	0,43	7,0
14	.47	1,75	25	18	59	168	10,1	44	1017	0,25	9,9
	.47	2	29	20	66	192	11,5	51	1256	0,31	9,2
	.55	2,5	37	22	71	220	13,2	58	1451	0,36	9,1
	.55	3	44	24	77	233	14	62	1734	0,43	8,1
16	.55	4	56	26	85	270	16,2	71	2123	0,52	7,6
	.62	2	29	23	75	242	14,5	64	1661	0,41	8,7
	.62	2,5	37	25	82	267	16	70	1963	0,48	8,2
	.62	3	44	26	85	297	17,8	78	2123	0,52	8,4
18	.62	4	56	28	90	342	20,5	90	2375	0,59	8,6
	.70	2,5	37	25	82	350	21	92	1963	0,48	10,7
	.70	3	44	28	92	375	22,5	99	2462	0,61	9,1
	.70	4	56	29	95	438	26,3	116	2641	0,65	10,0
	.70	5	70	32	105	470	28,2	124	3215	0,79	8,8

ENG

Gear Drive End Gun for Center Pivot systems . Gear drive, medium pressure (1,75 – 5 atm) and high capacity sprinkler head. Slow reverse rotation allows it to rotate full and semi circle in the same speed. Excellent and unique water distribution. Body angle of 18° is quite appropriate for portable or stationary systems at windy areas and at locations which requires irrigation from low level. Equipped with new type one-hole nozzle. Thus it operates with less water and minimize nozzle clogging problem arising from waste water. No clog nozzle makes it appropriate for use as ENDGUN at the portable irrigation machines and Center pivots.

ESP

Aspersor final con engranaje de transmisión para las Sistemas de Pivot central. Cabeza de rociador de presión media (1,75 - 5 atm) y alta capacidad. La rotación inversa lento permite que gire completa y semi vuelta en la misma velocidad. Excelente y única distribución del agua. Ángulo cuerpo de 18° es muy apropiado para sistemas portátiles o estacionarios en zonas con mucho viento y en lugares que requieren riego de bajo nivel. Equipado con un nuevo tipo de boquilla con un agujero. Por lo tanto, opera con menos agua y minimiza el problema de obstrucción de la boquilla que surge de agua sucia. Tobera sin bloqueo hace que sea adecuado para su uso como ENDGUN en las máquinas de riego portátiles y suspensiones centrales.

Yüzüak® Sprinklers

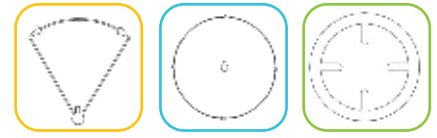

Part circle and Full circle Barrel cross section

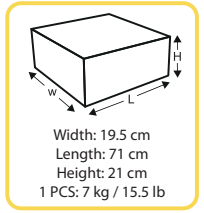

Water Input / El agua de entrada: 2"
Working Pressure / Presión de trabajo
2,5 – 6 kg/cm²
Water Requirement / Requerimientos de agua
10 m³/h – 32 m³/h
Nozzles / Boquilla
12mm – 14mm – 16mm – 18mm – 20mm – 22mm
Body Angle / Cuerpo Ángulo: 25°



Meme Çapı Nozzle diameter Diamètre de la tobera Durchmesser der Hauptdüse Diámetro ugello		Basınç Pressure Pression Presión Wasserdruck im Beregnert Pressione		Atış Yarı Çapı Jet Length Portée Chorro Tragweite Gittata		Su Tüketimi Capacity Débit Capacidad Kapazität Portata			Değerler bir Fıskiye için Values for a single sprinkler Données pour 1 arros. tout seul Datos para cada rociador Technische Daten für Einzelberegne Dati relativi ad 1 irrigatore		
mm	inch	kg/cm ²	lbs/inch	m	feet	l/min	m ³ /h	G.P.M.	Sulanan Alan Irrigated area Surface arrosée Superficie irrigada Beregnete Fläche Superficie irrigata	acre	Yağış Miktarı Rainfall per hour Pluviométrie horaire Intensidad horaria Wassermenge pro Stund Intensità oraria
mm/h											
12	.47	2,5	37	22	72	161,7	10	43	1519	0,38	6,4
	.47	3	44	24	79	176,7	11	47	1808	0,45	5,9
	.47	4	56	26	85	203,3	12	54	2122	0,52	5,7
14	.55	2,5	37	24	79	220	13	58	1808	0,45	7,3
	.55	3	44	26	85	233,3	14	62	2122	0,52	6,6
	.55	4	56	29	95	270	16	71	2640	0,65	6,1
16	.55	5	70	32	105	305	18	81	3215	0,79	5,7
	.62	2	29	26	85	241,7	15	64	2122	0,52	6,8
	.62	3	44	29	95	296,7	18	78	2640	0,65	6,7
18	.62	4	56	31	100	341,7	21	90	2920	0,72	7,0
	.62	5	70	33	108	386,7	23	102	3419	0,84	6,8
	.70	4	56	35	115	450	27	119	3846	0,95	7,0
18	.70	5	70	36	118	476,7	29	126	4069	1,01	7,0
	.70	6	85	38	125	526,7	32	139	4534	1,12	7,0

ENG

A sprinkler which rotates in a full-circle or in the range of angle settings you make when required, medium pressure. With its replaceable nozzles and moving water-breaking system, it enables you to irrigate your field with an excellent and uniform water distribution. It rotates in a full circle and semicircle at same speed. It is suitable for any use, agricultural or industrial. It has single-hole nozzle of new type. As it is, it operates with less water, minimizing problem of nozzle-clogging arising from waste water. Furthermore, it is also equipped with water pipe with specially designed vanes to prevent turbulence and rubber nozzle which stretches and expands when clogging. It has special paint of new type and it is much more durable against environmental factors thanks to new type powder paint. With its single-hole nozzle construction, adjustable moving water-breaker and body of 25°, this version is also conveniently used for any kind of agricultural application, discharge of waste water in the industry; evaporation of lakes and swamps and for dust suppression and similar industrial applications. Thanks to non-clogging nozzle section, it is very appropriate for use on travelling irrigators.

ESP

Cabezal de aspersión de alto rendimiento con capacidad de rotación de giro completo o en el rango de ajustes de ángulo deseado, equipado con transmisión y de presión media. Proporciona un riego óptimo con distribución homogénea del agua gracias a las boquillas de aspersor intercambiables y el sistema móvil de ruptura del agua. Capacidad de rotación de círculo completo y semicírculo a la misma velocidad. Apto para todo tipo de usos agrícolas e industriales. Cuenta con una boquilla nueva de un solo orificio. De esta manera, se logra que funcione con menos cantidad de agua y así como se reduce al mínimo el problema de la obstrucción de la boquilla. Cuenta con una tubería de flujo de agua con solapas de diseño especial que evita turbulencias y también dispone de una boquilla de caucho que se expande en caso de obstrucción para eliminar los residuos animales mediante dilución con agua en las granjas. Cuenta con una nueva pintura especial. Gracias a su pintura nueva en polvo, es más resistente a los factores ambientales. Apto para uso en todo tipo de aplicaciones agrícolas e industriales tales como la eliminación de las aguas residuales en la industria, la evaporación de lagos y pantanos, el control del polvo, etc. gracias a su cuerpo con ángulo de 25°, la estructura de boquilla con una sola salida y el rompedor de agua móvil y ajustable. Apto para uso en máquinas de riego móviles gracias al perfil de la boquilla anti obstrucción.

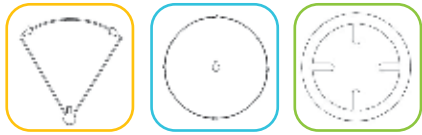

Part circle and Full circle Barrel cross section

Yüzziak®
Sprinklers

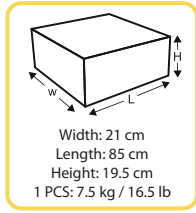

Width: 21 cm
Length: 85 cm
Height: 19.5 cm
1 PCS: 7.5 kg / 16.5 lb

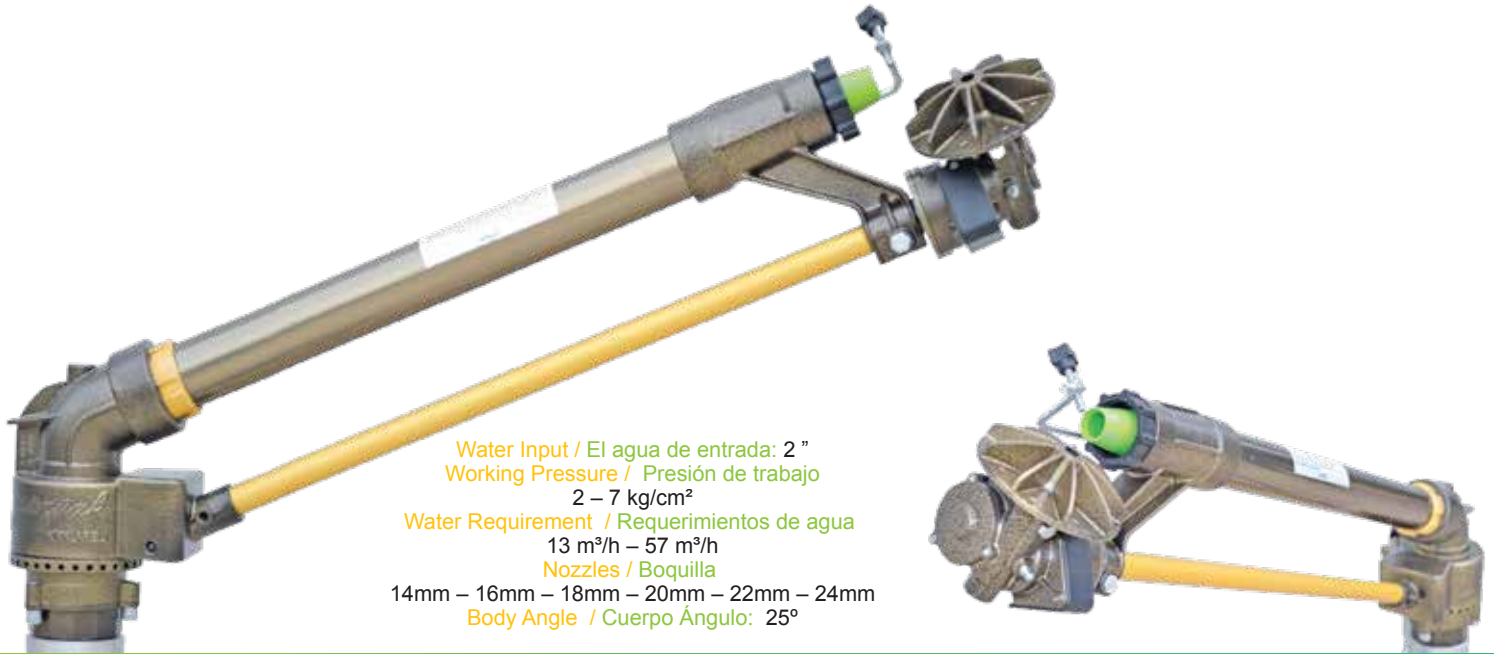

Water Input / El agua de entrada: 2"
Working Pressure / Presión de trabajo
2 – 7 kg/cm²
Water Requirement / Requerimientos de agua
13 m³/h – 57 m³/h
Nozzles / Boquilla
14mm – 16mm – 18mm – 22mm – 24mm
Body Angle / Cuerpo Ángulo: 25°

Meme Çapı Nozzle diameter Diamètre de la blouse Diámetro de la tobera Durchmesser der Hauptdüse Diametro ugello		Basınç Pressure Pression Presión Wasserdruck im Beregnern Pressione		Atış Yarı Çapı Jet Length Portée Chorro Tragweite Gittata		Su Tüketimi Capacity Débit Capacidad Kapazität Portata			Değerler bir Fiskiye içindir Values for a single sprinkler Données pour 1 arros. tout seul Datos para cada rociador Technische Daten für Einzelberegnere Dati relativi ad 1 irrigatore		
									Sulanan Alan Irrigated area Surface arrosée Superficie irrigada Beregnete Fläche Superficie irrigata	Yağış Miktarı Rainfall per hour Pluviométrie horaire Intensidad horaria Wassermenge pro Stund Intensità oraria	
mm	inch	kg/cm ²	lbs/inch	m	feet	l/min	m ³ /h	G.P.M.	m ²	acre	mm/h
14mm	.55	2.5	37	24	79	220	13.2	58	1808	0.45	7.3
	.55	3	44	26	85	233.3	14	62	2122	0.52	6.6
	.55	4	56	29	95	270	16.2	71	2640	0.65	6.1
16mm	.62	2	29	26	85	241.7	14.5	64	2122	0.52	6.8
	.62	3	44	29	95	296.7	17.8	78	2640	0.65	6.7
	.62	4	56	31	100	341.7	20.5	90	2920	0.72	7.0
18mm	.62	5	70	33	108	386.7	23.2	102	3419	0.84	6.8
	.70	3	44	32	105	375	22.5	99	3215	0.79	7.0
	.70	4	56	35	115	438.3	26.3	116	3846	0.95	6.8
20mm	.70	5	70	37	121	470	28.2	124	4298	1.06	6.6
	.70	6	85	40	131	521.7	31.3	138	5024	1.24	6.2
	.78	3	44	35	115	445	26.7	118	3846	0.95	6.9
22mm	.78	4	56	37	121	536.7	32.2	142	4298	1.06	7.5
	.78	5	70	42	138	591.7	35.5	156	5538	1.37	6.4
	.86	3	44	35	115	556.7	33.4	147	3846	0.95	8.7
24mm	.86	4	56	37	121	641.7	38.5	170	4298	1.06	9.0
	.86	5	70	40	131	716.7	43	189	5024	1.24	8.6
	.86	6	85	42	138	786.7	47.2	208	5538	1.37	8.5
24mm	.94	4	56	43	141	771.7	46.3	204	5805	1.43	8.0
	.94	5	70	45	148	801.7	48.1	212	6358	1.57	7.6
	.94	6	85	47	154	885	53.1	234	6936	1.71	7.7
	.94	7	100	50	164	950	57	251	7850	1.94	7.3

ENG

A sprinkler which rotates in a full-circle or in the range of angle settings you make when required, medium pressure. With its replaceable nozzles and moving water-breaking system, it enables you to irrigate your field with an excellent and uniform water distribution. It rotates in a full circle and semicircle at same speed. It is suitable for any use, agricultural or industrial. It has single-hole nozzle of new type. As it is, it operates with less water, minimizing problem of nozzle-clogging arising from waste water. Furthermore, it is also equipped with water pipe with specially designed vanes to prevent turbulence and rubber nozzle which stretches and expands when clogging. It has special paint of new type and it is much more durable against environmental factors thanks to new type powder paint. With its single-hole nozzle construction, adjustable moving water-breaker and body of 25°, this version is also conveniently used for any kind of agricultural application, discharge of waste water in the industry; evaporation of lakes and swamps and for dust suppression and similar industrial applications. Thanks to non-clogging nozzle section, it is very appropriate for use on travelling irrigators.

ESP

Cabezal de aspersión de alto rendimiento con capacidad de rotación de giro completo o en el rango de ajustes de ángulo deseado, equipado con transmisión y de presión media. Proporciona un riego óptimo con distribución homogénea del agua gracias a las boquillas de aspersor intercambiables y el sistema móvil de ruptura del agua. Capacidad de rotación de círculo completo y semicírculo a la misma velocidad. Apto para todo tipo de usos agrícolas e industriales. Cuenta con una boquilla nueva de un solo orificio. De esta manera, se logra que funcione con menos cantidad de agua y así como se reduce al mínimo el problema de la obstrucción de la boquilla. Cuenta con una tubería de flujo de agua con solapas de diseño especial que evita turbulencias y también dispone de una boquilla de caucho que se expande en caso de obstrucción para eliminar los residuos animales mediante dilución con agua en las granjas. Cuenta con una nueva pintura especial. Gracias a su pintura nueva en polvo, es más resistente a los factores ambientales. Apto para uso en todo tipo de aplicaciones agrícolas e industriales tales como la eliminación de las aguas residuales en la industria, la evaporación de lagos y pantanos, el control del polvo, etc. gracias a su cuerpo con ángulo de 25°, la estructura de boquilla con una sola salida y el rompedor de agua móvil y ajustable. Apto para uso en máquinas de riego móviles gracias al perfil de la boquilla anti obstrucción.

Yüzüak® Sprinklers

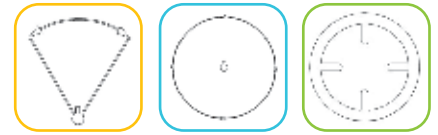

Part circle and Full circle Barrel cross section

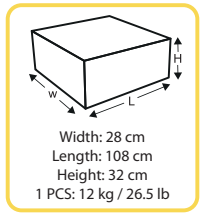

Water Input / El agua de entrada: Flange 130mm x 78mm
 Working Pressure / Presión de trabajo
 3 – 7 kg/cm²
 Water Requirement / Requerimientos de agua
 22 m³/h – 82 m³/h
 Nozzles / Boquilla
 18mm – 20mm – 22mm – 24mm – 26mm – 28mm
 Body Angle / Cuerpo Ángulo: 24°

Meme Çapı Nozzle diameter Diamètre de la bluse Diámetro de la tobera Durchmesser der Hauptdüse Diámetro ugello		Basınç Pressure Pression Presión Wasserdruck im Beregner Pressione		Atış Yarı Çapı Jet Length Portée Chorro Tragweite Gittata		Su Tüketimi Capacity Débit Capacidad Kapazität Portata			Değerler bir Fiskiye içindir Values for a single sprinkler Données pour 1 arros. tout seul Datos para cada rociador Technische Daten für Einzelberegner Dati relativi ad 1 irrigatore			
									Sulanan Alan Irrigated area Surface arrosée Superficie irrigada Beregnete Fläche Superficie irrigata		Yağış Miktarı Rainfall per hour Pluviométrie horaire Intensidad horaria Wassermenge pro Stund Intensità oraria	
mm	inch	kg/cm ²	lbs/inch	m	feet	l/min	m ³ /h	G.P.M.	m ²	acre	mm/h	
18mm	.70	3	44	32	105	375	22,5	99	3215	0,79	7,0	
	.70	4	56	35	115	438	26,3	116	3847	0,95	6,8	
	.70	5	70	37	121	470	28,2	124	4299	1,06	6,6	
	.70	6	85	40	131	522	31,3	138	5024	1,24	6,2	
20mm	.78	3	44	35	115	445	26,7	118	3847	0,95	6,9	
	.78	4	56	37	121	537	32,2	142	4299	1,06	7,5	
	.78	5	70	42	138	592	35,5	156	5539	1,37	6,4	
22mm	.86	3	44	35	115	557	33,4	147	3847	0,95	8,7	
	.86	4	56	37	121	642	38,5	170	4299	1,06	9,0	
	.86	5	70	40	131	717	43	189	5024	1,24	8,6	
	.86	6	85	42	138	787	47,2	208	5539	1,37	8,5	
24mm	.94	4	56	43	141	772	46,3	204	5806	1,43	8,0	
	.94	5	70	45	148	802	48,1	212	6359	1,57	7,6	
	.94	6	85	47	154	885	53,1	234	6936	1,71	7,7	
26mm	1	4	56	44	144	867	52	229	6079	1,50	8,6	
	1	5	70	46	151	967	58	255	6644	1,64	8,7	
	1	6	85	49	161	1067	64	282	7539	1,86	8,5	
28mm	1.1	5	70	50	164	1117	67	295	7850	1,94	8,5	
	1.1	6	85	50	164	1233	74	326	7850	1,94	9,4	
	1.1	7	100	53	174	1358	82	359	8820	2,18	9,2	

ENG

A sprinkler which rotates in a full-circle or in the range of angle settings you make when required, medium pressure. With its replaceable nozzles and moving water-breaking system, it enables you to irrigate your field with an excellent and uniform water distribution. It rotates in a full circle and semicircle at same speed. It is suitable for any use, agricultural or industrial. It has single-hole nozzle of new type. As it is, it operates with less water, minimizing problem of nozzle-clogging arising from waste water. Furthermore, it is also equipped with water pipe with specially designed vanes to prevent turbulence and rubber nozzle which stretches and expands when clogging. It has special paint of new type and it is much more durable against environmental factors thanks to new type powder paint. With its single-hole nozzle construction, adjustable moving water-breaker and body of 25°, this version is also conveniently used for any kind of agricultural application, discharge of waste water in the industry; evaporation of lakes and swamps and for dust suppression and similar industrial applications. Thanks to non-clogging nozzle section, it is very appropriate for use on travelling irrigators.

ESP

Cabezal de aspersión de alto rendimiento con capacidad de rotación de giro completo o en el rango de ajustes de ángulo deseado, equipado con transmisión y de presión media. Proporciona un riego óptimo con distribución homogénea del agua gracias a las boquillas de aspersor intercambiables y el sistema móvil de ruptura del agua. Capacidad de rotación de círculo completo y semicírculo a la misma velocidad. Apto para todo tipo de usos agrícolas e industriales. Cuenta con una boquilla nueva de un solo orificio. De esta manera, se logra que funcione con menos cantidad de agua y así como se reduce al mínimo el problema de la obstrucción de la boquilla. Cuenta con una tubería de flujo de agua con solapas de diseño especial que evita turbulencias y también dispone de una boquilla de caucho que se expande en caso de obstrucción para eliminar los residuos animales mediante dilución con agua en las granjas. Cuenta con una nueva pintura especial. Gracias a su pintura nueva en polvo, es más resistente a los factores ambientales. Apto para uso en todo tipo de aplicaciones agrícolas e industriales tales como la eliminación de las aguas residuales en la industria, la evaporación de lagos y pantanos, el control del polvo, etc. gracias a su cuerpo con ángulo de 25°, la estructura de boquilla con una sola salida y el rompedor de agua móvil y ajustable. Apto para uso en máquinas de riego móviles gracias al perfil de la boquilla anti obstrucción.



Full circle



Barrel cross section

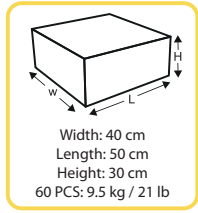

Main Nozzles



Black (4.5 mm) Yellow (5 mm) White (5.5 mm)

Back Nozzles

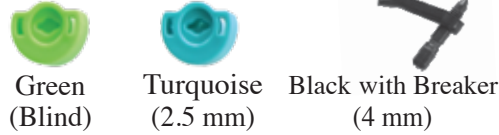

Green (Blind) Turquoise (2.5 mm) Black with Breaker (4 mm)



Water Input / El agua de entrada: 3/4"
Working Pressure / Presión de trabajo
2,0 – 3,5 kg/cm²
Water Requirement / Requerimientos de agua
1,55 m³/h – 3,00 m³/h
Nozzles / Boquilla
4,5mm – 5mm – 5,5mm
Body Angle / Cuerpo Ángulo: 25°

Nozzle diameter Diamètre de la bluse Diámetro de la tobera Durchmesser der Hauptdüse Diametro ugello	Pressure Pression Presión Wasserdruck im Beregner Pressione		Jet Length Portée Chorro Tragweite Gittata		Capacity Débit Capacidad Kapazität Portata			Values for a single sprinkler Données pour 1 arros. tout seul Datos para cada rociador Technische Daten für Einzelberegner Dati relativi ad 1 irrigatore		
	kg/cm ²	lbs/inch	m	feet	l/min	m ³ /h	G.P.M.	Irrigated area Surface arrosée Superficie irrigada Beregnete Fläche Superficie irrigata		Rainfall per hour Pluviométrie horaire Intensidad horaira Wassermenge pro Stunde Intensità oraria
mm	kg/cm ²	lbs/inch	m	feet	l/min	m ³ /h	G.P.M.	m ²	acre	mm/h
4,5mm (Drive Nozzle) x 2,5mm	2	29	13	42,64	26	1,55	6,8	531	0,13	2,92
	2,5	36	13,5	44,28	28	1,7	7,5	572	0,14	2,97
	3	43	14	45,92	30	1,82	8,0	615	0,15	2,96
	3,5	50	14,5	47,56	34	2,05	9,0	660	0,16	3,11
5mm (Drive Nozzle) x 2,5mm	2	29	14	45,92	29	1,75	7,7	615	0,15	2,84
	2,5	36	14,5	47,56	32	1,9	8,4	660	0,16	2,88
	3	43	15	49,2	35	2,1	9,2	707	0,17	2,97
	3,5	50	15,5	50,84	38	2,25	9,9	754	0,19	2,98
5mm (Drive Nozzle) x 4mm	2	29	14	45,92	33	1,95	8,6	615	0,15	3,17
	2,5	36	14,5	47,56	35	2,1	9,2	660	0,16	3,18
	3	43	15	49,2	38	2,3	10,1	707	0,17	3,26
	3,5	50	15,5	50,84	41	2,45	10,8	754	0,19	3,25
5,5mm (Drive Nozzle) x 4mm	2	29	14	45,92	39	2,35	10,3	615	0,15	3,82
	2,5	36	15	49,2	43	2,55	11,2	707	0,17	3,61
	3	43	15,5	50,84	48	2,85	12,5	754	0,19	3,78
	3,5	50	16	52,48	50	3	13,2	804	0,20	3,73

ENG

Atom 14 is a new model, Yüzüak Makina developed as a result of its R&D activities lasted 3 years. tom14 Models have special body construction, it 25 degrees, Furthermore, it's minimizing wind effect. As it is with all products of Yuzuak sprinklers, it is made of 100% original raw material and engineering plastics and professional additives are used to eliminate adverse effects of water and sun to serve for long years

ESP

Atom 14 es un modelo nuevo, desarrollado por Yüzüak Makina como resultado de sus actividades de I + D duraron 3 años. Los modelos tom14 tienen una construcción especial de carrocería, de 25 grados, además, minimiza el efecto del viento. Como ocurre con todos los productos de los aspersores Yuzuak, está hecho de materia prima 100% original y plásticos de ingeniería y se utilizan aditivos profesionales para eliminar los efectos adversos del agua y el sol para servir durante largos años.

Yüzüak® Sprinklers

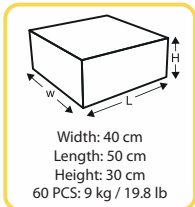
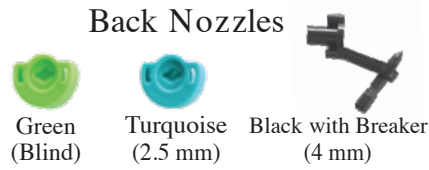
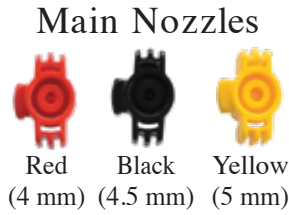
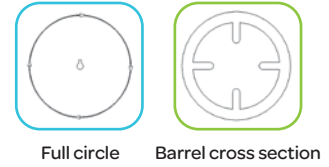

Water Input / El agua de entrada: 3/4"
Working Pressure / Presión de trabajo
2,0 – 3,5 kg/cm²
Water Requirement / Requerimientos de agua
1,10 m³/h – 2,25 m³/h
Nozzles / Boquilla
4mm - 4.5mm – 5mm
Body Angle / Cuerpo Ángulo: 25°

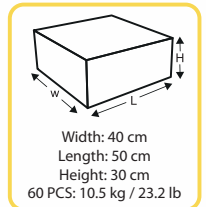

Nozzle diameter Diamètre de la bluse Diámetro de la tobera Durchmesser der Hauptdüse Diametro ugello	Pressure Pression Presión Wasserdruck im Beregner Pressione		Jet Length Portée Chorro Tragweite Gittata		Capacity Débit Capacidad Kapazität Portata			Values for a single sprinkler Données pour 1 arros. tout seul Datos para cada rociador Technische Daten für Einzelberegner Dati relativi ad 1 irrigatore		
	kg/cm ²	lbs/inch	m	feet	l/min	m ³ /h	G.P.M.	Irrigated area Surface arrosée Superficie irrigada Beregnete Fläche Superficie irrigata	acre	Rainfall per hour Pluviométrie horaire Intensidad horaria Wassermenge pro Stund Intensità oraria
mm	kg/cm ²	lbs/inch	m	feet	l/min	m ³ /h	G.P.M.	m ²	acre	mm/h
4mm (Drive Nozzle) x 2,5mm	2	29	12	39,4	18,3	1,1	4,8	452	0,11	2,4
	2,5	36	12,5	41,0	22,5	1,35	5,9	491	0,12	2,8
	3	43	13	42,6	24,2	1,45	6,4	531	0,13	2,7
	3,5	50	13,5	44,3	26,7	1,6	7,0	572	0,14	2,8
4,5mm (Drive Nozzle) x 2,5mm	2	29	12,5	41,0	25,8	1,55	6,8	491	0,12	3,2
	2,5	36	13	42,6	28,3	1,7	7,5	531	0,13	3,2
	3	43	13,5	44,3	30,3	1,82	8,0	572	0,14	3,2
	3,5	50	14	45,9	34,2	2,05	9,0	615	0,15	3,3
5mm (Drive Nozzle) x 2,5mm	2	29	13,5	44,3	29,2	1,75	7,7	572	0,14	3,1
	2,5	36	14	45,9	31,7	1,9	8,4	615	0,15	3,1
	3	43	14,5	47,6	35,0	2,1	9,2	660	0,16	3,2
	3,5	50	15	49,2	37,5	2,25	9,9	707	0,17	3,2

ENG

Atom 14 is a new model, Yüzüak Makina developed as a result of its R&D activities lasted 3 years. tom14 Models have special body construction, it 25 degrees, Furthermore, it's minimizing wind effect. As it is with all products of Yuzusak sprinklers, it is made of 100% original raw material and engineering plastics and professional additives are used to eliminate adverse effects of water and sun to serve for long years

ESP

Atom 14 es un modelo nuevo, desarrollado por Yüzüak Makina como resultado de sus actividades de I + D duraron 3 años. Los modelos tom14 tienen una construcción especial de carrocería, de 25 grados, además, minimiza el efecto del viento. Como ocurre con todos los productos de los aspersores Yuzusak, está hecho de materia prima 100% original y plásticos de ingeniería y se utilizan aditivos profesionales para eliminar los efectos adversos del agua y el sol para servir durante largos años.

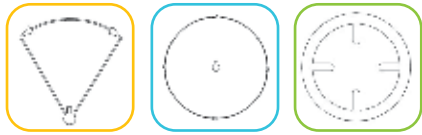

Part circle and Full circle Barrel cross section

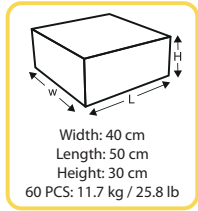

Width: 40 cm
Length: 50 cm
Height: 30 cm
60 PCS: 11.7 kg / 25.8 lb

Main Nozzles

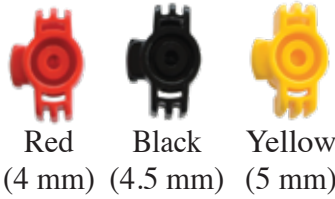

Red (4 mm) Black (4.5 mm) Yellow (5 mm)

Yüzüak®
Sprinklers



Water Input / El agua de entrada: 3/4"
Working Pressure / Presión de trabajo
2,0 – 3,5 kg/cm²
Water Requirement / Requerimientos de agua
0,9 m³/h – 1,80 m³/h
Nozzles / Boquilla
4 mm – 4,5 mm - 5 mm
Body Angle / Cuerpo Ángulo: 25°

Nozzle diameter Diamètre de la bluse Diámetro de la tobera Durchmesser der Hauptdüse Diametro ugello	Pressure Pression Presi òn Wasserdruck im Beregner Pressione		Jet Length Portée Chorro Tragweite Gittata		Capacity Débit Capacidad Kapazität Portata			Values for a single sprinkler Données pour 1 arros. tout seul Datos para cada rociador Technische Daten für Einzelberegner Dati relativi ad 1 irrigatore		
	kg/cm ²	lbs/inch	m	feet	l/min	m ³ /h	G.P.M.	Irrigated area Surface arrosée Superficie irrigada Beregnete Fläche Superficie irrigata	acre	Rainfall per hour Pluviométrie horaire Intensidad horaria Wassermenge pro Stund Intensità oraria
4 mm	2	29	13	42.6	15.0	0.9	4.0	531	0.13	1.7
	2.5	36	13.5	44.3	16.0	0.96	4.2	572	0.14	1.7
	3	43	14.2	46.6	17.5	1.05	4.6	633	0.16	1.7
	3.5	50	14.6	47.9	20.8	1.25	5.5	669	0.17	1.9
4,5 mm	2	29	13	42.6	17.5	1.05	4.6	531	0.13	2.0
	2.5	36	13.5	44.3	19.7	1.18	5.2	572	0.14	2.1
	3	43	14.5	47.6	21.5	1.29	5.7	660	0.16	2.0
5 mm	3.5	50	15	49.2	23.3	1.4	6.2	707	0.17	2.0
	2	29	14	45.9	22.5	1.35	5.9	615	0.15	2.2
	2.5	36	15	49.2	24.3	1.46	6.4	707	0.17	2.1
	3	43	15.5	50.8	26.5	1.59	7.0	754	0.19	2.1
	3.5	50	16	52.5	28.7	1.72	7.6	804	0.20	2.1

ENG

Highly efficient sprinkler rotating in full circle or partial circle, impact-type, operating at low and medium pressure (2 – 3.5 atm). Thanks to replaceable sprinkler nozzles and single-hole water outlet, it ensures you to irrigate your field with minimum water and excellent uniform water distribution. You may use it for irrigation of any kind of field crops and vegetables. With body angle of 25°, it shows high performance under windy conditions. It has quick-connect nozzle construction. It may also be used for industrial applications, e.g. at the road edges mines, construction sites and for dust suppression. It is made of 100% original raw material and it is not affected by adverse effects of medium-degree chemicals and sun due to the special additives it contains.

ESP

Cabezal de aspersión de alto rendimiento con capacidad de rotación de giro completo o en el rango de ajustes de ángulo deseado, de tipo impacto y de presión baja y media (2 – 3.5 atm). Proporciona un riego óptimo con mínimo cantidad de agua y con distribución homogénea del agua gracias a las boquillas de aspersor intercambiables y un solo orificio de salida de agua. Apto para el riego de todo tipo de cultivos de campo y verduras. Proporciona un rendimiento alto en zonas con viento gracias a su cuerpo de ángulo de 25°. Dispone de boquilla de quita y pon. Apto para usos en áreas industriales tales como el control del polvo, en las obras de construcción, en las minas y en los bordes de las carreteras. Fabricado a partir de materia prima 100% original. Gracias a los aditivos especiales, es resistente a los productos químicos moderados y los efectos nocivos del sol.

Yüzüak® Sprinklers



Main Nozzles

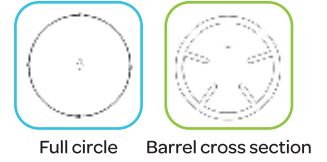
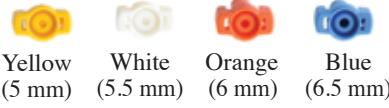

Back Nozzles

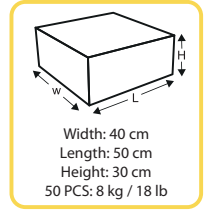
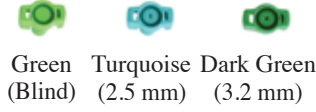

CIT* tested	Atom 15 FC	15x15m
	CU in %	90
	DU in %	84

*Center of Irrigation Technologies
Fresno, California/USA

†1 Nozzle size 4 x 3,2 mm 3 bar



Water Input / El agua de entrada: 1" Working Pressure / Presión de trabajo 2 – 4.5 kg/cm²
Water Requirement / Requerimientos de agua 2 m³/h – 4.05 m³/h
Nozzles / Boquilla 5 mm – 5,5mm – 6mm – 6,5mm
Body Angle / Cuerpo Ángulo: 22° - 27°



Meme Çapı Nozzle diameter Diámetro de la bluse Durchmesser der Hauptdüse Diámetro ugello	Basınç Pressure Presión Presion		Atış Yarı Çapı Jet Length Portée Chorro Tragweite Gittata		Su Tüketimi Capacity Débit Capacidad Kapazität Portata			Değerler bir Fıskiye içindir Values for a single sprinkler Données pour 1 arros. tout seul Datos para cada rociador Technische Daten für Einzelberegne Dati relativi ad 1 irrigatore		
	kg/cm ²	lbs/inch	m	feet	l/min	m ³ /h	G.P.M.	Sulanan Alan Irrigated area Surface arrosée Superficie irrigada Beregnete Fläche Superficie irrigata	acre	Yağış Miktarı Rainfall per hour Pluviométrie horaire Intensidad horaira Wassermenge pro Stund Intensità oraria
5mm (Drive Nozzle) x 3,2mm	2,0	29	14,0	46	33,3	2,00	8,8	615	0,15	3,2
	2,5	36	15,0	49	36,7	2,20	9,7	707	0,17	3,1
	3,0	43	15,5	51	39,2	2,35	10,3	754	0,19	3,1
	3,5	50	16,0	52	44,2	2,65	11,7	804	0,20	3,3
	4,5	64	16,5	54	49,2	2,95	13,0	855	0,21	3,5
5,5mm (Drive Nozzle) x 3,2mm	2,0	29	14,5	48	37,5	2,25	9,9	660	0,16	3,4
	2,5	36	15,5	51	40,8	2,45	10,8	754	0,19	3,2
	3,0	43	16,0	52	45,8	2,75	12,1	804	0,20	3,4
	3,5	50	16,5	54	48,3	2,90	12,8	855	0,21	3,4
	4,5	64	17,4	57	54,2	3,25	14,3	951	0,23	3,4
6mm (Drive Nozzle) x 3,2mm	2,0	29	15,0	49	40,0	2,40	10,6	707	0,17	3,4
	2,5	36	16,0	52	44,2	2,65	11,7	804	0,20	3,3
	3,0	43	16,5	54	48,3	2,90	12,8	855	0,21	3,4
	3,5	50	17,0	56	54,2	3,25	14,3	907	0,22	3,6
	4,5	64	18,0	59	60,8	3,65	16,1	1017	0,25	3,6
6,5 (Drive Nozzle) x 3,2mm	2,0	29	15,5	51	45,8	2,75	12,1	754	0,19	3,6
	2,5	36	16,5	54	50,8	3,05	13,4	855	0,21	3,6
	3,0	43	16,7	55	54,2	3,25	14,3	876	0,22	3,7
	3,5	50	17,2	56	59,2	3,55	15,6	929	0,23	3,8
	4,5	64	18,1	59	67,5	4,05	17,8	1029	0,25	3,9

ENG

A new and licensed version Yüzüak Makina developed as a result of its R&D activities lasted 2 years. Thanks to its special body construction, it has two different water spray angle, i.e. 22° and 27 degrees. Furthermore, it has adjustable rotation speed. The sprinkler head is designed to operate with both body angles. Water outlet of 22° is recommended for windy conditions. In this way, it may spray the water at lower height, minimizing wind effect. At the sites subject to normal wind, you may use body angle of 27° for optimum irrigation. With the nozzle given together with and used as blind plug, you may also use the sprinkler head with single hole. As it is with all products of Yüzüak Makina, it is made of 100% original raw material and engineering plastics and professional additives are used to eliminate adverse effects of water and sun to serve for long years.

ESP

Modelo nuevo patentado y desarrollado por Yüzüak Máquina tras 2 años de investigaciones de I+D. Dispone de dos distintos ángulos de disparo de agua de 22 y 27 grados gracias a su cuerpo especial. Además cuenta con velocidad de rotación ajustable. El cabezal de aspersión está diseñado para funcionar con ambos ángulos de cuerpo. En zonas con viento, se recomienda utilizar la salida de agua de 22°. De esta manera, se minimiza el efecto del viento disparando el agua a baja altura. En zonas con viento moderado, se recomienda utilizar el ángulo de cuerpo de 27° para un riego óptimo. Gracias a su boquilla que se utiliza como tapón ciego, el cabezal de aspersión se puede utilizar también con un solo orificio de salida. Como todos los productos de Yüzüak Máquina, este producto ha sido fabricado con materias primas 100% originales y plásticos de ingeniería y aditivos profesionales para alargar la vida útil y paliar los efectos nocivos del sol y el agua.

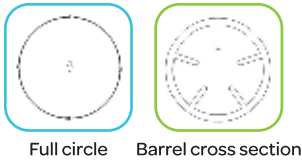

Full circle Barrel cross section

Main Nozzles



Back Nozzles



Green (Blind) Turquoise (2.5 mm) Dark Green (3.2 mm)

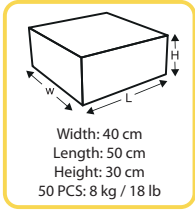

Width: 40 cm
Length: 50 cm
Height: 30 cm
50 PCS: 8 kg / 18 lb

CIT* tested	Atom 15 LF	12 x 12mm
	CU in %	89
	DU in %	88

*Center of Irrigation Technologies
Fresno, California/USA

1) Nozzle Size: 4.8 x 5.5 mm 1.8 inch



Water Input / El agua de entrada: 1"
Working Pressure / Presión de trabajo
2 – 4.5 kg/cm²
Water Requirement / Requerimientos de agua
1,1 m³/h – 2,55 m³/h
Nozzles / Boquilla
4mm – 4,5mm – 5mm
Body Angle / Cuerpo Ángulo: 22° - 27°

Meme Çapı Nozzle diameter Diámetro de la tobera Durchmesser der Hauptdüse Diámetro ugello	Basınç Pressure Pression Presión Wasserdruck im Beregnr Pressione		Atış Yarı Çapı Jet Length Portée Chorro Tragweite Gittata		Su Tüketimi Capacity Débit Capacidad Kapazität Portata			Değerler bir Fıskiye içindir Values for a single sprinkler Données pour 1 arros. tout seul Datos para cada rociador Technische Daten für Einzelberegnr Dati relativi ad 1 irrigatore		
	kg/cm ²	lbs/inch	m	feet	l/min	m ³ /h	G.P.M.	m ²	acre	mm/h
4mm (Drive Nozzle) x 2,5mm	2,0	29	13,0	43	18,3	1,10	4,8	531	0,13	2,1
	2,5	36	13,5	44	22,5	1,35	5,9	572	0,14	2,4
	3,0	43	14,2	47	24,2	1,45	6,4	633	0,16	2,3
	3,5	50	14,6	48	27,5	1,65	7,3	669	0,17	2,5
	4,5	64	15,0	49	30,3	1,82	8,0	707	0,17	2,6
4,5mm (Drive Nozzle) x 2,5mm	2,0	29	13,0	43	25,8	1,55	6,8	531	0,13	2,9
	2,5	36	13,5	44	28,3	1,70	7,5	572	0,14	3,0
	3,0	43	14,5	48	30,3	1,82	8,0	660	0,16	2,8
	3,5	50	15,0	49	34,2	2,05	9,0	707	0,17	2,9
	4,5	64	15,5	51	37,5	2,25	9,9	754	0,19	3,0
5mm (Drive Nozzle) x 2,5mm	2,0	29	14,0	46	29,2	1,75	7,7	615	0,15	2,8
	2,5	36	15,0	49	32,5	1,95	8,6	707	0,17	2,8
	3,0	43	15,5	51	35,8	2,15	9,5	754	0,19	2,9
	3,5	50	16,0	52	38,3	2,30	10,1	804	0,20	2,9
	4,5	64	16,5	54	42,5	2,55	11,2	855	0,21	3,0

ENG

A new and licensed version Yüzüak Makina developed as a result of its R&D activities lasted 2 years. Thanks to its special body construction, it has two different water spray angle, i.e. 22 and 27 degrees. Furthermore, it has adjustable rotation speed. The sprinkler head is designed to operate with both body angles. Water outlet of 22o is recommended for windy conditions. In this way, it may spray the water at lower height, minimizing wind effect. At the sites subject to normal wind, you may use body angle of 27o for optimum irrigation. With the nozzle given together with and used as blind plug, you may also use the sprinkler head with single hole. As it is with all products of Yüzüak Makina, it is made of 100% original raw material and engineering plastics and professional additives are used to eliminate adverse effects of water and sun to serve for long years.

ESP

Modelo nuevo patentado y desarrollado por Yüzüak Máquina tras 2 años de investigaciones de I+D. Dispone de dos distintos ángulos de disparo de agua de 22 y 27 grados gracias a su cuerpo especial. Además cuenta con velocidad de rotación ajustable. El cabezal de aspersión está diseñado para funcionar con ambos ángulos de cuerpo. En zonas con viento, se recomienda utilizar la salida de agua de 22°. De esta manera, se minimiza el efecto del viento disparando el agua a baja altura. En zonas con viento moderado, se recomienda utilizar el ángulo de cuerpo de 27° para un riego óptimo. Gracias a su boquilla que se utiliza como tapón ciego, el cabezal de aspersión se puede utilizar también con un solo orificio de salida. Como todos los productos de Yüzüak Máquina, este producto ha sido fabricado con materias primas 100% originales y plásticos de ingeniería y aditivos profesionales para alargar la vida útil y paliar los efectos nocivos del sol y el agua.

Yüziak® Sprinklers



Part circle and Full circle Barrel cross section

Main Nozzles

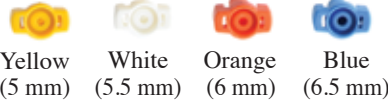

Yellow (5 mm) White (5.5 mm) Orange (6 mm) Blue (6.5 mm)



Water Input / El agua de entrada: 1" Working Pressure / Presión de trabajo 2 – 4.5 kg/cm²
Water Requirement / Requerimientos de agua 1,3 m³/h – 3,3 m³/h
Nozzles / Boquilla 5mm – 5,5mm – 6mm – 6,5mm
Body Angle / Cuerpo Ángulo: 23°

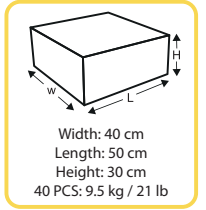

Meme Çapı Nozzle diameter Diamètre de la bluse Diámetro de la tobera Durchmesser der Hauptdüse Diámetro ugello	Basiç Pressure Pression Presión Wasserdruck im Beregner Pressione		Atış Yarı Çapı Jet Length Portée Chorro Tragweite Gittata		Su Tüketimi Capacity Débit Capacidad Kapazität Portata			Değerler bir Fıskiye içindir Values for a single sprinkler Données pour 1 arros. tout seul Datos para cada rociador Technische Daten für Einzelberegner Dati relativi ad 1 irrigatore		
								Sulanan Alan Irrigated area Surface arrosée Superficie irrigada Beregnete Fläche Superficie irrigata	Yağış Miktarı Rainfall per hour Pluviométrie horaire Intensidad horaria Wassermenge pro Stunde Intensità oraria	
mm	kg/cm ²	lbs/inch	m	feet	l/min	m ³ /h	G.P.M.	m ²	acre	mm/h
5 mm	2.0	29	14.0	46	22.5	1.35	5.9	615	0.15	2.2
	2.5	36	15.0	49	24.3	1.46	6.4	707	0.17	2.1
	3.0	43	15.5	51	26.5	1.59	7.0	754	0.19	2.1
	3.5	50	16.0	52	28.7	1.72	7.6	804	0.20	2.1
	4.5	64	16.5	54	32.5	1.95	8.6	855	0.21	2.3
5,5 mm	2.0	29	14.5	48	26.3	1.58	7.0	660	0.16	2.4
	2.5	36	15.5	51	29.3	1.76	7.7	754	0.19	2.3
	3.0	43	16.0	52	32.2	1.93	8.5	804	0.20	2.4
	3.5	50	16.5	54	34.7	2.08	9.2	855	0.21	2.4
	4.5	64	17.4	57	39.3	2.36	10.4	951	0.23	2.5
6 mm	2.0	29	15.0	49	31.3	1.88	8.3	707	0.17	2.7
	2.5	36	16.2	53	35.0	2.10	9.2	824	0.20	2.5
	3.0	43	17.1	56	38.3	2.30	10.1	918	0.23	2.5
	3.5	50	18.0	59	41.3	2.48	10.9	1017	0.25	2.4
	4.5	64	19.5	64	46.8	2.81	12.4	1194	0.29	2.4
6,5 mm	2.0	29	15.4	51	36.7	2.20	9.7	745	0.18	3.0
	2.5	36	16.5	54	41.0	2.46	10.8	855	0.21	2.9
	3.0	43	17.5	57	45.0	2.70	11.9	962	0.24	2.8
	3.5	50	18.4	60	48.5	2.91	12.8	1063	0.26	2.7
	4.5	64	20.0	66	55.0	3.30	14.5	1256	0.31	2.6

ENG Highly efficient sprinkler rotating in full circle or partial circle, impact-type, operating at low and medium pressure (1.5 – 4 atm) Thanks to replaceable sprinkler nozzles and single-hole water outlet, it ensures you to irrigate your field with minimum water and excellent uniform water distribution. You may use it for irrigation of any kind of field crops and vegetables. With body angle of 23°, it shows high performance under windy conditions. It has quick-connect nozzle construction. It may also be used for industrial applications, e.g. at the road edges mines, construction sites and for dust suppression. It is made of 100% original raw material and it is not affected by adverse effects of medium-degree chemicals and sun due to the special additives it contains.

ESP Cabezal de aspersión de alto rendimiento con capacidad de rotación de giro completo o en el rango de ajustes de ángulo deseado, de tipo impacto y de presión baja y media (1,5 - 4 atm). Proporciona un riego óptimo con mínima cantidad de agua y con distribución homogénea del agua gracias a las boquillas de aspersor intercambiables y un solo orificio de salida de agua. Apto para el riego de todo tipo de cultivos de campo y verduras. Proporciona un rendimiento alto en zonas con viento gracias a su cuerpo de ángulo de 23°. Dispone de boquilla de quita y pon. Apto para usos en áreas industriales tales como el control del polvo, en las obras de construcción, en las minas y en los bordes de las carreteras. Fabricado a partir de materia prima 100% original. Gracias a los aditivos especiales, es resistente a los productos químicos moderados y los efectos nocivos del sol.

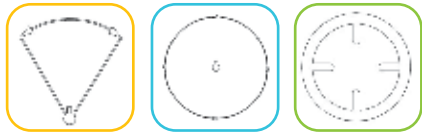

Part circle and Full circle Barrel cross section

Main Nozzles



Red (4 mm) Black (4.5 mm) Yellow (5 mm)

Yüzziak®
Sprinklers



Water Input / El agua de entrada: 1" Working Pressure / Presión de trabajo 2 – 4,5 kg/cm²
Water Requirement / Requerimientos de agua 1.00 m³/h – 2 m³/h
Nozzles / Boquilla 4mm – 4.5mm – 5mm
Body Angle / Cuerpo Ángulo: 23°

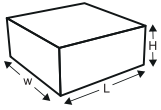

Width: 40 cm
Length: 50 cm
Height: 30 cm
40 PCS: 9.5 kg / 21 lb

Meme Çapı Nozzle diameter Diámetro de la bluse Durchmesser der Hauptdüse Diámetro ugello	Basınç Pressure Pression Presión Wasserdruck im Beregner Pressione		Atış Yarı Çapı Jet Length Portée Chorro Tragweite Gittata		Su Tüketimi Capacity Débit Capacidad Kapazität Portata			Değerler bir Fıskiye içindir Values for a single sprinkler Données pour 1 arros. tout seul Datos para cada rociador Technische Daten für Einzelberegner Dati relativi ad 1 irrigatore		
	kg/cm ²	lbs/inch	m	feet	l/min	m ³ /h	G.P.M.	Sulanan Alan Irrigated area Surface arrosée Superficie irrigada Beregnete Fläche Superficie irrigata		Yağış Miktarı Rainfall per hour Pluviométrie horaire Intensidad horaira Wassermenge pro Stund Intensità oraria
4 mm	2.0	29	13.0	43	15.0	0.90	4.0	531	0.13	1.7
	2.5	36	13.5	44	16.0	0.96	4.2	572	0.14	1.7
	3.0	43	14.2	47	17.5	1.05	4.6	633	0.16	1.7
	3.5	50	14.6	48	20.8	1.25	5.5	669	0.17	1.9
	4.5	64	15.0	49	24.7	1.48	6.5	707	0.17	2.1
4,5 mm	2.0	29	13.0	43	17.5	1.05	4.6	531	0.13	2.0
	2.5	36	13.5	44	19.7	1.18	5.2	572	0.14	2.1
	3.0	43	14.5	48	21.5	1.29	5.7	660	0.16	2.0
	3.5	50	15.0	49	23.3	1.40	6.2	707	0.17	2.0
	4.5	64	15.5	51	26.3	1.58	7.0	754	0.19	2.1
5 mm	2.0	29	14.0	46	22.5	1.35	5.9	615	0.15	2.2
	2.5	36	15.0	49	24.3	1.46	6.4	707	0.17	2.1
	3.0	43	15.5	51	26.5	1.59	7.0	754	0.19	2.1
	3.5	50	16.0	52	28.7	1.72	7.6	804	0.20	2.1
	4.5	64	16.5	54	32.5	1.95	8.6	855	0.21	2.3

ENG

Highly efficient sprinkler rotating in full circle or partial circle, impact-type, operating at low and medium pressure (1.5 – 4 atm) Thanks to replaceable sprinkler nozzles and single-hole water outlet, it ensures you to irrigate your field with minimum water and excellent uniform water distribution. You may use it for irrigation of any kind of field crops and vegetables. With body angle of 23°, it shows high performance under windy conditions. It has quick-connect nozzle construction. It may also be used for industrial applications, e.g. at the road edges mines, construction sites and for dust suppression. It is made of 100% original raw material and it is not affected by adverse effects of medium-degree chemicals and sun due to the special additives it contains.

ESP

Cabezal de aspersión de alto rendimiento con capacidad de rotación de giro completo o en el rango de ajustes de ángulo deseado, de tipo impacto y de presión baja y media (1,5 - 4 atm). Proporciona un riego óptimo con mínimo cantidad de agua y con distribución homogénea del agua gracias a las boquillas de aspersor intercambiables y un solo orificio de salida de agua. Apto para el riego de todo tipo de cultivos de campo y verduras. Proporciona un rendimiento alto en zonas con viento gracias a su cuerpo de ángulo de 23°. Dispone de boquilla de quita y pon. Apto para usos en áreas industriales tales como el control del polvo, en las obras de construcción, en las minas y en los bordes de las carreteras. Fabricado a partir de materia prima 100% original. Gracias a los aditivos especiales, es resistente a los productos químicos moderados y los efectos nocivos del sol.

Yüzüak® Sprinklers



Main Nozzles

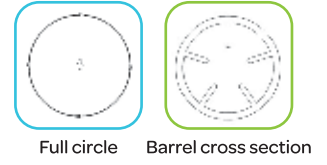

Back Nozzles

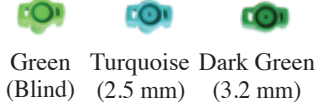

Water Input / El agua de entrada: 1"
 Working Pressure / Presión de trabajo
 2 – 4,5 kg/cm²
 Water Requirement / Requerimientos de agua
 1,75 m³/h – 3.25 m³/h
 Nozzles / Boquilla
 5mm – 5.5mm – 6mm
 Body Angle / Cuerpo Ángulo: 7° - 10°

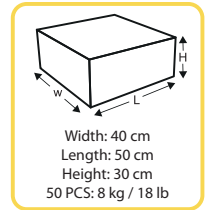

Meme Çapı Nozzle diameter Diamètre de la bluse Diámetro de la tobera Durchmesser der Hauptdüse Diámetro ugello	Basınç Pressure Pression Presión Wasserdruck im Beregner Pressione		Atış Yarı Çapı Jet Length Portée Chorro Tragweite Gittata		Su Tüketimi Capacity Débit Capacidad Kapazitätä Portata			Değerler bir Fıskiye içindir Values for a single sprinkler Données pour 1 arros. tout seul Datos para cada rociador Technische Daten für Einzelberegne Dati relativi ad 1 irrigatore		
								Sulanan Alan Irrigated area Surface arrosée Superficie irrigada Beregnete Fläche Superficie irrigata	Yağış Miktarı Rainfall per hour Pluviométrie horaire Intensidad horaira Wassermenge pro Stund Intensità oraria	
mm	kg/cm ²	lbs/inch	m	feet	l/min	m ³ /h	G.P.M.	m ²	acre	mm/h
5,0 mm x 2,5mm (10°)	2,0	29	9,2	30	29,2	1,75	7,7	268	0,07	6,5
	2,5	36	9,9	33	32,5	1,95	8,6	311	0,08	6,3
	3,0	43	10,5	35	35,8	2,15	9,5	348	0,09	6,2
	3,5	50	11,1	36	38,3	2,30	10,1	383	0,09	6,0
	4,5	64	12,0	39	42,5	2,55	11,2	449	0,11	5,7
5,5 mm x 2,5mm (10°)	2,0	29	9,6	31	34,2	2,05	9,0	287	0,07	7,2
	2,5	36	10,2	33	36,7	2,20	9,7	327	0,08	6,7
	3,0	43	10,9	36	41,7	2,50	11,0	370	0,09	6,8
	3,5	50	11,4	37	44,2	2,65	11,7	406	0,10	6,5
	4,5	64	12,4	41	49,2	2,95	13,0	479	0,12	6,2
6,0 mm x 2,5mm (10°)	2,0	29	9,8	32	35,8	2,15	9,5	298	0,07	7,2
	2,5	36	10,5	35	40,0	2,40	10,6	348	0,09	6,9
	3,0	43	11,1	36	44,2	2,65	11,7	388	0,10	6,8
	3,5	50	11,7	38	49,2	2,95	13,0	430	0,11	6,9
	4,5	64	12,7	42	54,2	3,25	14,3	504	0,12	6,4

ENG

A new and licensed version Yüzüak Makina developed as a result of its R&D activities lasted 2 years. Thanks to its special body construction, it has two different water spray angle, i.e. 7 and 10 degrees. With the nozzle given together with and used as blind plug, you may also use the sprinkler head with single hole. It is usually used for irrigation of pistachio tree and, additionally, it may be used for under-tree irrigation as well. It is also used as irrigation gun at the windy places. Like all products manufactured by Yüzüak Makina, it is made of 100% original raw material and engineering plastics and professional additives are used to eliminate adverse effects of water and sun to serve for long years.

ESP

Modelo nuevo patentado y desarrollado por Yüzüak Máquina tras 2 años de investigaciones de I+D. Dispone de dos distintos ángulos de disparo de agua de 7 y 10 grados gracias a su cuerpo especial. Gracias a su boquilla que se utiliza como tapón ciego, el cabezal de aspersión se puede utilizar con un solo orificio de salida. En general, se utiliza para el riego de pistacheros. Se utiliza también en el riego subterráneo de todo tipo de árboles. Apto para uso como pistola de aspersión en zonas con viento. Como todos los productos de Yüzüak Máquina, este producto ha sido fabricado de materias primas 100% originales y plásticos de ingeniería y aditivos profesionales para alargar la vida útil y paliar los efectos nocivos del sol y el agua.

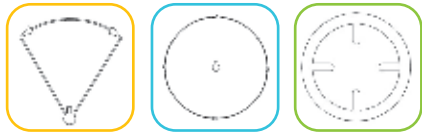

Part circle and Full circle Barrel cross section

Yüzüak®
Sprinklers

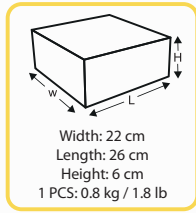

CIT* tested	Atom 22	15 x 20m
	CU In %	92
	DU In %	85

*Center of Irrigation Technologies Fresno, California, USA
* Nozzle size 6 mm 9 bar

Water Input / El agua de entrada: 1 " Working Pressure / Presión de trabajo 1,5 – 4 kg/cm²
Water Requirement / Requerimientos de agua 2,4 m³/h – 8,6 m³/h
Nozzles / Boquilla 6mm – 8mm – 10mm
Body Angle / Cuerpo Ángulo: 27°

Meme Çapı Nozzle diameter Diámetro de la bluse Diámetro de la tobera Durchmesser der Hauptdüse Diámetro ugello		Basınç Pressure Pression Presión Wasserdruck im Beregner Pressione		Atış Yarı Çapı Jet Length Portée Chorro Tragweite Gittata		Su Tüketimi Capacity Débit Capacidad Kapazität Portata			Değerler bir Fıskiye içindir Values for a single sprinkler Données pour 1 arros. tout seul Datos para cada rociador Technische Daten für Einzelberegner Dati relativi ad 1 irrigatore		
mm	inch	kg/cm ²	lbs/inch	m	feet	l/min	m ³ /h	G.P.M.	m ²	acre	mm/h
6mm	0,236	1,5	22	13,0	43	40	2,4	11	531	0,13	4,5
	0,236	2	29	15,0	49	46	2,8	12	707	0,17	4,0
	0,236	3	44	17,0	56	56	3,4	15	907	0,22	3,7
	0,236	4	56	18,0	59	65	3,9	17	1017	0,25	3,8
8mm	0,31	1,5	29	14,5	48	61	3,7	16	660	0,16	5,6
	0,31	2	44	16,5	54	71	4,3	19	855	0,21	5,0
	0,31	3	56	18,0	59	86	5,2	23	1017	0,25	5,1
	0,31	4	70	19,0	62	100	6,0	26	1134	0,28	5,3
10mm	0,39	2	29	17,0	56	102	6,1	27	907	0,22	6,7
	0,39	3	44	19,5	64	124	7,4	33	1194	0,29	6,2
	0,39	4	56	21,0	69	144	8,6	38	1385	0,34	6,2

ENG Highly efficient sprinkler rotating in full circle or partial circle, impact-type, operating at medium pressure (2.0 – 4 atm) Thanks to replaceable sprinkler ends and double-hole water outlet, it ensures you to irrigate your field with uniform water distribution. You may use it for irrigation of any kind of field crops and vegetables. It is appropriate for use with stationary and traveling systems. It may also be used for industrial applications, e.g. at the road edges mines, construction sites and for dust suppression. Thanks to the blind plug that comes with the system as standard, the second hole can be plugged for near-distance irrigation. As it is, it can also be operated with less water.

ESP Cabezal de aspersión de alto rendimiento con capacidad de rotación de giro completo o en el rango de ajustes de ángulo deseado, de tipo impacto y de presión media (2,0 - 4 atm). Proporciona un riego óptimo con una distribución homogénea del agua gracias a las boquillas de aspersor intercambiables y el doble orificio de salida de agua. Apto para el riego de todo tipo de cultivos de campo y verduras. Apto para uso en sistemas fijos y móviles. Apto para uso en el control del polvo en las obras de construcción, los depósitos de carbón, las minas y en los bordes de las carreteras. Gracias a su tapón ciego que cierra el segundo orificio de salida de agua, proporciona riego en distancias cortas. De esta manera, funciona con menos cantidad de agua.

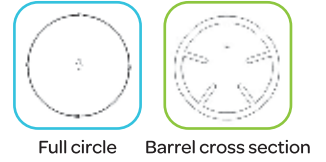

**ATOM
22 ECO
FC**

**ATOM
22 FC**

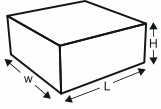

Width: 22 cm
Length: 26 cm
Height: 6 cm
25 PCS: 10 kg / 22 lb

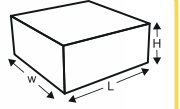

Width: 22 cm
Length: 26 cm
Height: 6 cm
1 PCS: 0.7 kg / 1.7 lb

Water Input / El agua de entrada: 1"
Working Pressure / Presión de trabajo
1,5 – 4 kg/cm²
Water Requirement / Requerimientos de agua
2,4 m³/h – 8,8 m³/h
Nozzles / Boquilla
6mm – 8mm – 10mm
Body Angle / Cuerpo Ángulo: 27°

Meme Çapı Nozzle diameter Diámetro de la bluse Diámetro de la tobera Durchmesser der Hauptdüse Diámetro ugello		Basınç Pressure Pression Presión Wasserdruck im Beregner Pressione		Atış Yarı Çapı Jet Length Portée Chorro Tragweite Gittata		Su Tüketimi Capacity Débit Capacidad Kapazität Portata			Değerler bir Fıskiye içindir Values for a single sprinkler Données pour 1 arros. tout seul Datos para cada rociador Technische Daten für Einzelberegner Dati relativi ad 1 irrigatore		
									Sulanan Alan Irrigated area Surface arrosée Superficie irrigada Beregnete Fläche Superficie irrigata		Yağış Miktarı Rainfall per hour Pluviométrie horaire Intensidad horaria Wassermenge pro Stund Intensità oraria
mm	inch	kg/cm ²	lbs/inch	m	feet	l/min	m ³ /h	G.P.M.	m ²	acre	mm/h
6mm	0,236	1,5	22	13,0	43	40	2,4	11	531	0,13	4,5
	0,236	2	29	15,0	49	46	2,8	12	707	0,17	4,0
	0,236	3	44	17,0	56	56	3,4	15	907	0,22	3,7
	0,236	4	56	18,0	59	65	3,9	17	1017	0,25	3,8
8mm	0,31	1,5	29	14,5	48	61	3,7	16	660	0,16	5,6
	0,31	2	44	16,5	54	71	4,3	19	855	0,21	5,0
	0,31	3	56	18,0	59	86	5,2	23	1017	0,25	5,1
	0,31	4	70	19,0	62	100	6,0	26	1134	0,28	5,3
10mm	0,39	2	29	17,0	56	102	6,1	27	907	0,22	6,7
	0,39	3	44	19,5	64	124	7,4	33	1194	0,29	6,2
	0,39	4	56	21,0	69	144	8,6	38	1385	0,34	6,2

ENG Highly efficient sprinkler rotating in full circle impact-type, operating at medium pressure (2.0 – 4 atm) Thanks to replaceable sprinkler ends and double-hole water outlet, it ensures you to irrigate your field with uniform water distribution. You may use it for irrigation of any kind of field crops and vegetables. It is appropriate for use with stationary and traveling systems. It may also be used for industrial applications, e.g. at the road edges mines, construction sites and for dust suppression. Thanks to the blind plug that comes with the system as standard, the second hole can be plugged for near-distance irrigation. As it is, it can also be operated with less water.

ESP Cabezal de aspersión de alto rendimiento con capacidad de rotación de giro completo, de tipo impacto y de presión media (2,0 - 4 atm). Proporciona un riego óptimo con una distribución homogénea del agua gracias a las boquillas de aspersor intercambiables y el doble orificio de salida de agua. Apto para el riego de todo tipo de cultivos de campo y verduras. Apto para uso en sistemas fijos y móviles. Apto para uso en el control del polvo en las obras de construcción, los depósitos de carbón, las minas y en los bordes de las carreteras. Gracias a su tapón ciego que cierra el segundo orificio de salida de agua, proporciona riego en distancias cortas. De esta manera, funciona con menos cantidad de agua.

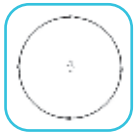

Full circle



Barrel cross section

Main Nozzles

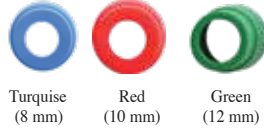

Turquoise
(8 mm)

Red
(10 mm)

Green
(12 mm)

Yüzüak®
Sprinklers

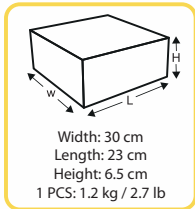
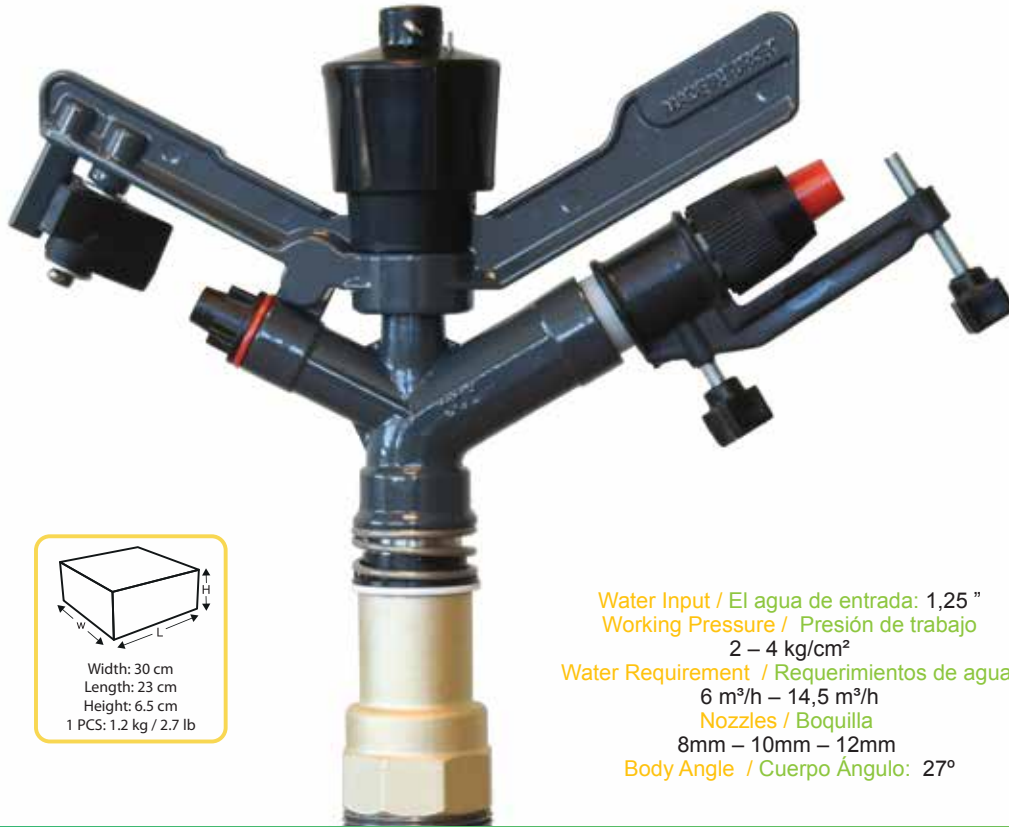

Width: 30 cm
Length: 23 cm
Height: 6.5 cm
1 PCS: 1.2 kg / 2.7 lb

Water Input / El agua de entrada: 1,25 "
Working Pressure / Presión de trabajo
2 – 4 kg/cm²
Water Requirement / Requerimientos de agua
6 m³/h – 14,5 m³/h
Nozzles / Boquilla
8mm – 10mm – 12mm
Body Angle / Cuerpo Angulo: 27°

Meme Çapı Nozzle diameter Diámetro de la tobera Durchmesser der Hauptdüse Diámetro ugello		Basınç Pressure Pression Presión Wasserdruck im Beregner Pressione		Atış Yarı Çapı Jet Length Portée Chorro Tragweite Gittata		Su Tüketimi Capacity Débit Capacidad Kapazitätä Portata			Değerler bir Fıskiye için dir Values for a single sprinkler Données pour 1 arros. tout seul Datos para cada rociador Technische Daten für Einzelberegne Dati relativi ad 1 irrigatore		
mm	inch	kg/cm ²	lbs/inch	m	feet	l/min	m ³ /h	G.P.M.	m ²	acre	mm/h
7X8	.31	2	29	17	56	100	6,00	26	907	0,22	6,6
	.31	3	44	19	62	121	7,25	32	1134	0,28	6,4
	.31	4	56	21	69	142	8,50	37	1385	0,34	6,1
7X10	.39	2	29	18	59	130	7,80	34	1017	0,25	7,7
	.39	3	44	21	69	160	9,60	42	1385	0,34	6,9
	.39	4	56	23	74	185	11,10	49	1590	0,39	7,0
7X12	.47	2	29	19	62	168	10,10	44	1134	0,28	8,9
	.47	3	44	22	72	207	12,40	55	1520	0,38	8,2
	.47	4	56	25	82	242	14,50	64	1963	0,48	7,4

ENG

An impact sprinkler that rotates in a full circle. It has double-hole outlet and rotating nozzle is replaceable. It is used for full turn only. It operates at medium and high pressure (2 – 4 bar). With adjustable water breaker, it allows uniform irrigation. And thanks to body angle of 27 degrees, it is less affected by wind compared to its equivalents of 30 and 33 degrees. Main body is aluminium with rotating mechanism of lower body made of aluminium and brass. Latent type sealing system, it serves with sandy water without any problem.

ESP

Cabezal de aspersión de tipo impacto con capacidad de rotación de giro completo. Cuenta con una salida con dos orificios y la boquilla rotativa es intercambiable. Apto para utilizar solo en giro completo. Capacidad de funcionamiento en presión media y alta (2-4 bares). Proporciona un riego uniforme gracias a su rompedor de agua ajustable. Se ve menos afectado del viento respecto a los modelos similares de 30 y 33 grados gracias al ángulo de cuerpo de 27 grados. El cuerpo principal es de aluminio. El mecanismo giratorio inferior se compone de aluminio y latón. Capacidad de funcionamiento en aguas arenosos gracias a su sistema de sellado de tipo oculto.



Part circle and Full circle Barrel cross section



Main Nozzles

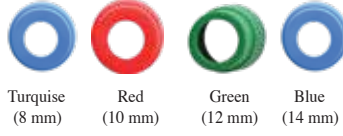

Water Input / El agua de entrada: 1,5"
Working Pressure / Presión de trabajo
2 – 5 kg/cm²
Water Requirement / Requerimientos de agua
6 m³/h – 18 m³/h
Nozzles / Boquilla
8mm – 10mm – 12mm – 14mm
Body Angle / Cuerpo Ángulo: 27°

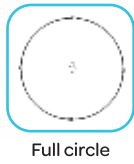
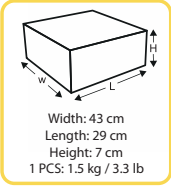

Full circle

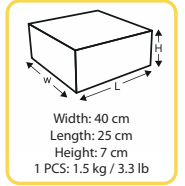

Meme Çapı Nozzle diameter Diámetro de la tobera Durchmesser der Hauptdüse Diámetro ugello		Basiç Pressure Pression Presi ön Wasserdruck im Beregner Pressione		Atış Yarı Çapı Jet Length Portée Chorro Tragweite Gittata		Su Tüketimi Capacity Débit Capacidad Kapazitätä Portata			Değerler bir Fıskiye içindir Values for a single sprinkler Données pour 1 arros. tout seul Datos para cada rociador Technische Daten für Einzelberegner Dati relativi ad 1 irrigatore		
									Irrigated Area		Rainfall per hour
									Sulanan Alan Irrigated area Surface arrosée Superficie irrigada Beregnete Fläche Superficie irrigata		Yağış Miktarı per hour Pluviométrie horaire Intensidad horaira Wassermenge pro Stund Intensità oraria
mm	inch	kg/cm ²	lbs/inch	m	feet	l/min	m ³ /h	G.P.M.	m ²	acre	mm/h
7 x 8	.31	2	30	17.0	55.8	100	6.0	26	907.5	0.2	6.61
	.31	3	45	19.0	62.3	116.7	7.0	31	1133.5	0.3	6.18
	.31	4	56	21.0	68.9	133.3	8.0	35	1384.7	0.3	5.78
7 X 10	.39	2	30	18.0	59.0	125	7.5	33	1017.4	0.3	7.37
	.39	3	45	21.0	68.9	155	9.3	41	1384.7	0.3	6.72
	.39	4	56	22.5	73.8	180	10.8	48	1589.6	0.4	6.79
7 X 12	.47	2	30	19.0	62.3	163.3	9.8	43	1133.5	0.3	8.65
	.47	3	45	22.0	72.2	200	12.0	53	1519.8	0.4	7.90
	.47	4	56	25.0	82.0	236.7	14.2	63	1962.5	0.5	7.24
7 X 14	.55	2	30	22.0	72.2	211.7	12.7	56	1519.8	0.4	8.36
	.55	3	45	25.0	82.0	241.7	14.5	64	1962.5	0.5	7.39
	.55	4	56	27.0	88.6	300	18.0	79	2289.1	0.6	7.86

ENG Highly efficient sprinkler rotating in full circle and partial circle, impact-type, operating at medium pressure (2.0 – 4 atm) Thanks to replaceable sprinkler ends and double-hole water outlet, it ensures you to irrigate your field with uniform water distribution. You may use it for irrigation of any kind of field crops and vegetables. It is appropriate for use with stationary and traveling systems. It may also be used for industrial applications, e.g. at the road edges mines, construction sites and for dust suppression.

ESP Cabezal de aspersión de alto rendimiento con capacidad de rotación de giro completo o en el rango de ajustes de ángulo deseado, de tipo impacto y de presión media (2,0 - 4 atm). Proporciona un riego óptimo con una distribución homogénea del agua gracias a las boquillas de aspersor intercambiables y el doble orificio de salida de agua. Apto para el riego de todo tipo de cultivos de campo y verduras. Apto para uso en sistemas fijos y móviles. Apto para uso en el control del polvo en las obras de construcción, los depósitos de carbón, las minas y en los bordes de las carreteras. Gracias a su tapón ciego que cierra el segundo orificio de salida de agua, proporciona riego en distancias cortas.

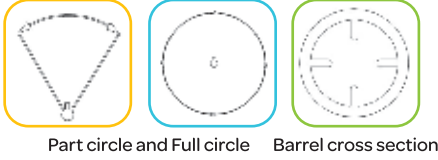

Part circle and Full circle Barrel cross section

Main Nozzles

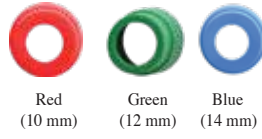

Red (10 mm) Green (12 mm) Blue (14 mm)

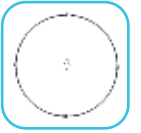
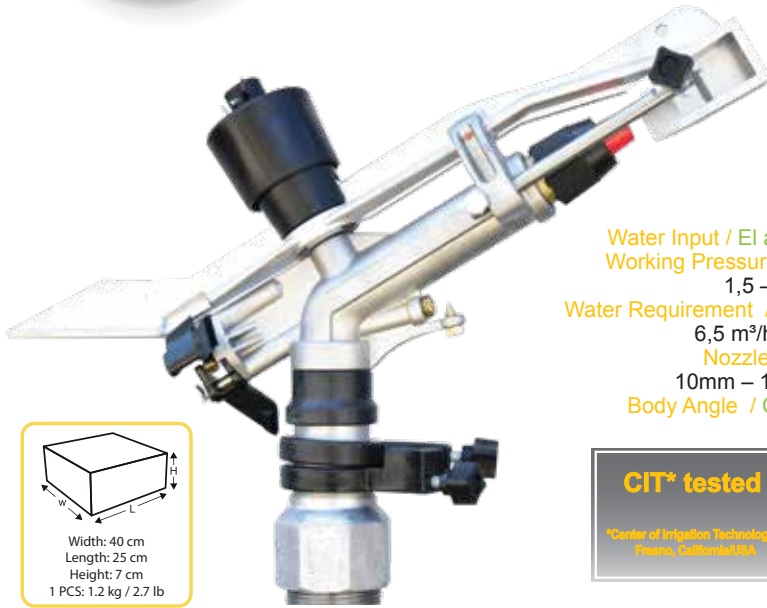
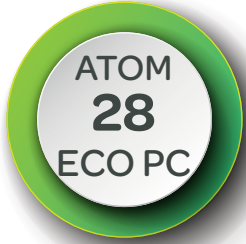

Full circle

Water Input / El agua de entrada: 1,5”
Working Pressure / Presión de trabajo
1,5 – 4 kg/cm²
Water Requirement / Requerimientos de agua
6,5 m³/h – 16,5 m³/h
Nozzles / Boquilla
10mm – 12mm – 14mm
Body Angle / Cuerpo Ángulo: 28°

CIT* tested

*Center of Irrigation Technologies
Fresno, California

Atom 28	25 x 21m
CU In %	90
DU In %	84

* Nozzle size 12 mm 4 bar

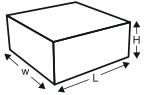

Width: 40 cm
Length: 25 cm
Height: 7 cm
1 PCS: 1.2 kg / 2.7 lb

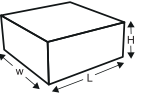

Width: 40 cm
Length: 25 cm
Height: 7 cm
1 PCS: 1.1 kg / 2.4 lb

Meme Çapı Nozzle diameter Diamètre de la bluse Diámetro de la tobera Durchmesser der Hauptdüse Diámetro ugello		Basınç Pressure Pression Presión Wasserdruck im Beregner Pressione		Atış Yarı Çapı Jet Length Portée Chorro Tragweite Gittata		Su Tüketimi Capacity Débit Capacidad Kapasität Portata			Değerler bir Fıskiye içindir Values for a single sprinkler Données pour 1 arros. tout seul Datos para cada rociador Technische Daten für Einzelberegner Dati relativi ad 1 irrigatore		
									Sulanan Alan Irrigated area Surface arrosée Superficie irrigada Beregnete Fläche Superficie irrigata		Yağış Miktarı Rainfall per hour Pluviométrie horaire Intensidad horaira Wassermenge pro Stund Intensità oraria
mm	inch	kg/cm ²	lbs/inch	m	feet	l/min	m ³ /h	G.P.M.	m ²	acre	mm/h
10	.39	2,00	29	19	62	108	6,5	29	1134	0,28	5,7
	.39	3,00	44	21	69	130	7,8	34	1385	0,34	5,6
	.39	4,00	56	23	75	152	9,1	40	1661	0,41	5,5
12	.47	2,00	29	21,0	69	152	9,0	40	1385	0,34	6,5
	.47	3,00	44	23,0	75	182	11,2	49	1661	0,41	6,7
	.47	4,00	56	25,5	84	211	13,0	57	2042	0,50	6,4
14	.55	2,00	29	22,0	72	195	12,0	53	1520	0,38	7,9
	.55	3,00	44	23,5	77	239	14,1	62	1734	0,43	8,1
	.55	4,00	56	27,0	89	277	16,5	73	2289	0,57	7,2

ENG

Highly efficient sprinkler rotating in full circle, part circle impact-type, operating at medium pressure (1,5 – 4 atm) Thanks to replaceable sprinkler ends and double-hole water outlet, it ensures you to irrigate your field with uniform water distribution. You may use it for irrigation of any kind of field crops and vegetables. It may also be used for industrial applications, e.g. at the road edges mines, construction sites and for dust suppression.

ESP

Cabezal de aspersión de alto rendimiento con capacidad de rotación de giro completo o en el rango de ajustes de ángulo deseado, de tipo impacto y de presión media (1,5 - 4 atm). Proporciona un riego óptimo con una distribución homogénea del agua gracias a las boquillas de aspersor intercambiables y el doble orificio de salida de agua. Apto para el riego de todo tipo de cultivos de campo y verduras. Apto para uso en el control del polvo en las obras de construcción, los depósitos de carbón, las minas y en los bordes de las carreteras. Gracias a su tapón ciego que cierra el segundo orificio de salida de agua, proporciona riego en distancias cortas.



Part circle and Full circle Barrel cross section

Main Nozzles

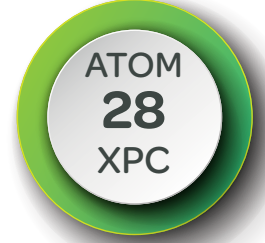
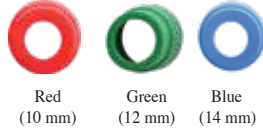

Full circle

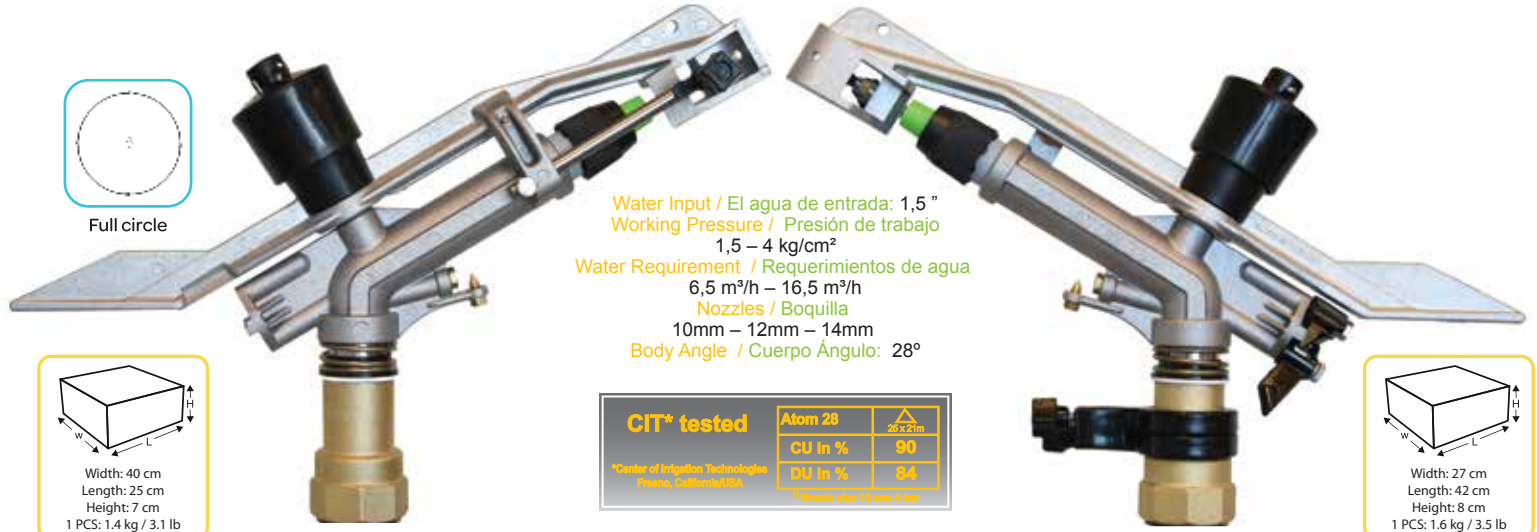
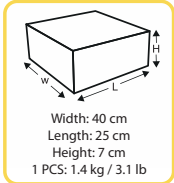

Water Input / El agua de entrada: 1,5 " Working Pressure / Presión de trabajo 1,5 – 4 kg/cm²
Water Requirement / Requerimientos de agua 6,5 m³/h – 16,5 m³/h
Nozzles / Boquilla 10mm – 12mm – 14mm
Body Angle / Cuerpo Ángulo: 28°

CIT* tested	Atom 28	28 x 28m
	CU in %	90
	DU in %	84

*Center of Irrigation Technologies Fresno, California

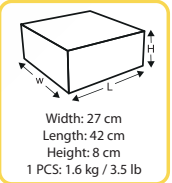

Meme Çapı Nozzle diameter Diamètre de la bluse Diámetro de la tobera Durchmesser der Hauptdüse Diámetro ugello		Basınç Pressure Pression Presión Wasserdruck im Beregnen Pressione		Atış Yarı Çapı Jet Length Portée Chorro Tragweite Gittata		Su Tüketimi Capacity Débit Capacidad Kapazität Portata			Değerler bir Fiskiye içindir Values for a single sprinkler Données pour 1 arros. tout seul Datos para cada rociador Technische Daten für Einzelberegne Dati relativi ad 1 irrigatore		
									Sulanan Alan Irrigated area Surface arrosée Superficie irrigada Beregnete Fläche Superficie irrigata		Yağış Miktarı Rainfall per hour Pluviométrie horaire Intensidad horaire Wassermenge pro Stund Intensità oraria
mm	inch	kg/cm ²	lbs/inch	m	feet	l/min	m ³ /h	G.P.M.	m ²	acre	mm/h
10	.39	2,00	29	19	62	108	6,5	29	1134	0,28	5,7
	.39	3,00	44	21	69	130	7,8	34	1385	0,34	5,6
	.39	4,00	56	23	75	152	9,1	40	1661	0,41	5,5
12	.47	2,00	29	21,0	69	152	9,0	40	1385	0,34	6,5
	.47	3,00	44	23,0	75	182	11,2	49	1661	0,41	6,7
	.47	4,00	56	25,5	84	211	13,0	57	2042	0,50	6,4
14	.55	2,00	29	22,0	72	195	12,0	53	1520	0,38	7,9
	.55	3,00	44	23,5	77	239	14,1	62	1734	0,43	8,1
	.55	4,00	56	27,0	89	277	16,5	73	2289	0,57	7,2

ENG Highly efficient sprinkler rotating in full circle, part circle impact-type, operating at medium pressure (1,5 – 4 atm) Thanks to replaceable sprinkler ends and double-hole water outlet, it ensures you to irrigate your field with uniform water distribution. You may use it for irrigation of any kind of field crops and vegetables. It may also be used for industrial applications, e.g. at the road edges mines, construction sites and for dust suppression.

ESP Cabezal de aspersión de alto rendimiento con capacidad de rotación de giro completo o en el rango de ajustes de ángulo deseado, de tipo impacto y de presión media (1,5 - 4 atm). Proporciona un riego óptimo con una distribución homogénea del agua gracias a las boquillas de aspersor intercambiables y el doble orificio de salida de agua. Apto para el riego de todo tipo de cultivos de campo y verduras. Apto para uso en el control del polvo en las obras de construcción, los depósitos de carbón, las minas y en los bordes de las carreteras. Gracias a su tapón ciego que cierra el segundo orificio de salida de agua, proporciona riego en distancias cortas.

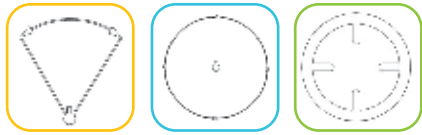

Part circle and Full circle Barrel cross section

Main Nozzles

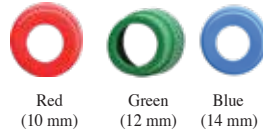

Red (10 mm) Green (12 mm) Blue (14 mm)

Yüzüak® Sprinklers



Water Input / El agua de entrada: 1,5 "
Working Pressure / Presión de trabajo
1,5 – 5 kg/cm²
Water Requirement / Requerimientos de agua
6,5 m³/h – 18,8 m³/h
Nozzles / Boquilla
10mm – 12mm – 14mm
Body Angle / Cuerpo Ángulo: 28°

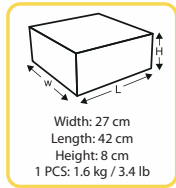

Width: 27 cm
Length: 42 cm
Height: 8 cm
1 PCS: 1.6 kg / 3.4 lb

CIT* tested	Atom 28	25 x 21m
	CU In %	90
	DU In %	84

*Center of Irrigation Technologies
France, Certification

¹⁾ Nozzle size 12 mm 4 Bar

Meme Çapı Nozzle diameter Diamètre de la bluse Diámetro de la tobera Durchmesser der Hauptdüse Diámetro ugello		Basınç Pressure Pression Presión Wasserdruck im Beregnr Pressione		Atış Yarı Çapı Jet Length Portée Chorro Tragweite Gittata		Su Tüketimi Capacity Débit Capacidad Kapasität Portata			Değerler bir Fıskiye içindir Values for a single sprinkler Données pour 1 arros. tout seul Datos para cada rociador Technische Daten für Einzelberegner Dati relativi ad 1 irrigatore		
mm	inch	kg/cm ²	lbs/inch	m	feet	l/min	m ³ /h	G.P.M.	Sulanan Alan Irrigated area Surface arrosée Superficie irrigada Beregnete Fläche Superficie irrigata		Yağış Miktarı Rainfall per hour Pluviométrie horaire Intensidad horaira Wassermenge pro Stund Intensità oraria
		m ²	acre			mm/h					
10	.39	2,00	29	19	62	108	6,5	29	1134	0,28	5,7
	.39	3,00	44	21	69	130	7,8	34	1385	0,34	5,6
	.39	4,00	56	23	75	152	9,1	40	1661	0,41	5,5
	.39	5,00	70	23,5	77	236	10,5	46	1734	0,43	6,1
12	.47	2,00	29	21,0	69	152	9,0	40	1385	0,34	6,5
	.47	3,00	44	23,0	75	182	11,2	49	1661	0,41	6,7
	.47	4,00	56	25,5	84	211	13,0	57	2042	0,50	6,4
14	.47	5,00	70	26,5	87	236	14,2	63	2205	0,54	6,4
	.55	2,00	29	22,0	72	195	12,0	53	1520	0,38	7,9
	.55	3,00	44	23,5	77	239	14,1	62	1734	0,43	8,1
	.55	4,00	56	27,0	89	277	16,5	73	2289	0,57	7,2
	.55	5,00	70	28,0	92	309	18,8	83	2462	0,61	7,6

ENG Highly efficient sprinkler rotating in full circle or partial circle, impact-type, operating at medium pressure (2.0 – 5 atm) Thanks to replaceable sprinkler ends and adjustable water breaker, it ensures you to irrigate your field with uniform water distribution. It is appropriate to use for dust control at roadsides, mines, construction sites and coal depots. Main body and scoop is aluminium with lower rotating mechanism made of brass, Teflon and stainless steel. It is equipped with a system allowing use of standard stationary breaker or licenced moving breaker. Moving breaker breaks water without preventing it to reach long distances. Thanks to the setting mechanism on the breaker, water may be broken less or more. With the blind plug that comes with it as standard, the second hole for irrigation of short distances can be plugged. And this allows less water consumption.

ESP Cabezal de aspersión de alto rendimiento con capacidad de rotación de giro completo o en el rango de ajustes de ángulo deseado, de tipo impacto y de presión media (2.0 - 5 atm). Proporciona un riego óptimo con mínimo cantidad de agua y con una distribución homogénea del agua gracias a las boquillas de aspersor intercambiables y el doble orificio de salida de agua. Apto para el riego de todo tipo de cultivos de campo y verduras. Apto para uso en sistemas fijos y móviles. Apto para uso en el control del polvo en las obras de construcción, los depósitos de carbón, las minas y en los bordes de las carreteras. El cuerpo principal y la cuchara son de aluminio y el mecanismo giratorio inferior se compone de teflón, latón y acero inoxidable. Dispone de un sistema que permite el uso de un rompedor fijo o un rompedor móvil patentado. El rompedor móvil rompe el agua sin impedir que alcance a largas distancias. Gracias al mecanismo de ajuste del rompedor, el agua puede romperse más o menos. Gracias a su tapón ciego que cierra el segundo orificio de salida de agua, proporciona riego en distancias cortas. De esta manera, funciona con menos cantidad de agua.

Yüziak® Sprinklers



Part circle and Full circle Barrel cross section

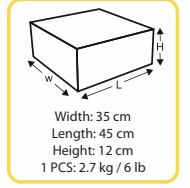

Water Input / El agua de entrada: 1,5 "
Working Pressure / Presión de trabajo
2 – 6 kg/cm²
Water Requirement / Requerimientos de agua
9m³/h – 32 m³/h
Nozzles / Boquilla
12mm – 14mm – 16mm – 18mm
Body Angle / Cuerpo Ángulo: 27°

CIT* tested	Atom 35	
	CU In %	91
	DU In %	85

*Center of Irrigation Technologies
Pleasanton, California, USA
1 Nozzle also 14 x 6 mm Ø bar

Meme Çapı Nozzle diameter Diamètre de la tobera Durchmesser der Hauptdüse Diametro ugello	Basınç Pressure Pression Presión Wasserdruck im Beregnen Pressione		Atış Yarı Çapı Jet Length Portée Chorro Tragweite Gittata		Su Tüketimi Capacity Débit Capacidad Kapazität Portata			Değerler bir Fıskiye içindir Values for a single sprinkler Données pour 1 arros. tout seul Datos para cada rociador Technische Daten für Einzelberegner Dati relativi ad 1 irrigatore			
								Sulanan Alan Irrigated area Surface arrosée Superficie irrigada Beregnete Fläche Superficie irrigata		Yağış Miktarı Rainfall per hour Pluviométrie horaire Intensidad horaria Wassermenge pro Stund Intensità oraria	
mm	inch	kg/cm ²	lbs/inch	m	feet	l/min	m ³ /h	G.P.M.	m ²	acre	mm/h
12	.47	2	29	20,0	66	155	9,3	41	1256	0,31	7,4
	.47	3	44	24,0	79	187	11,2	49	1809	0,45	6,2
	.47	4	56	27,0	89	217	13,0	57	2289	0,57	5,7
	.47	5	70	28,0	92	237	14,2	63	2462	0,61	5,8
14	.55	2	29	21,0	69	202	12,1	53	1385	0,34	8,7
	.55	3	44	25,0	82	242	14,5	64	1963	0,48	7,4
	.55	4	56	29,0	95	282	16,9	74	2641	0,65	6,4
	.55	5	70	30,0	98	315	18,9	83	2826	0,70	6,7
16	.62	2	29	22,0	72	253	15,2	67	1520	0,38	10,0
	.62	3	44	26,0	85	315	18,9	83	2123	0,52	8,9
	.62	4	56	30,0	98	358	21,5	95	2826	0,70	7,6
	.62	5	70	32,0	105	400	24,0	106	3215	0,79	7,5
18	.70	3	44	27,0	89	385	23,1	102	2289	0,57	10,1
	.70	4	56	30,0	98	450	27,0	119	2826	0,70	9,6
	.70	5	70	34,0	112	502	30,1	133	3630	0,90	8,3
	.70	6	85	35,0	115	542	32,5	143	3847	0,95	8,4

ENG Highly efficient sprinkler rotating in full circle or partial circle, impact-type, operating at medium pressure (2.0 – 6 atm) Thanks to replaceable sprinkler ends and adjustable water breaker, it ensures you to irrigate your field with uniform water distribution. It is appropriate to use for dust control at roadsides, mines, construction sites and coal depots. Main body and scoop is aluminium with lower rotating mechanism made of brass, Teflon and stainless steel. It is equipped with a system allowing use of standard stationary breaker or licenced moving breaker. Moving breaker breaks water without preventing it to reach long distances. Thanks to the setting mechanism on the breaker, water may be broken less or more. With the blind plug that comes with it as standard, the second hole for irrigation of short distances can be plugged. And this allows less water consumption.

ESP Cabezal de aspersión de alto rendimiento con capacidad de rotación de giro completo o en el rango de ajustes de ángulo deseado, de tipo impacto y de presión media (2,0 - 6 atm). Proporciona un riego óptimo con mínimo cantidad de agua y con una distribución homogénea del agua gracias a las boquillas de aspersor intercambiables y el doble orificio de salida de agua. Apto para el riego de todo tipo de cultivos de campo y verduras. Apto para uso en sistemas fijos y móviles. Apto para uso en el control del polvo en las obras de construcción, los depósitos de carbón, las minas y en los bordes de las carreteras. El cuerpo principal y la cuchara son de aluminio y el mecanismo giratorio inferior se compone de teflón, latón y acero inoxidable. Dispone de un sistema que permite el uso de un rompedor fijo o un rompedor móvil patentado. El rompedor móvil rompe el agua sin impedir que alcance a largas

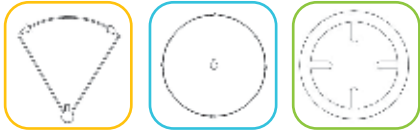

Part circle and Full circle Barrel cross section

Main Nozzles



Blue (14 mm) Black (16 mm) Green (18 mm) Yellow (20 mm)

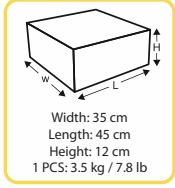

Water Input / El agua de entrada: 2 "
Working Pressure / Presión de trabajo
2 – 5 kg/cm²
Water Requirement / Requerimientos de agua
11 m³/h – 32 m³/h
Nozzles / Boquilla
14mm – 16mm – 18mm – 20mm
Body Angle / Cuerpo Ángulo: 24°

Meme Çapı Nozzle diameter Diamètre de la buse Diámetro de la tobera Durchmesser der Hauptdüse Diámetro ugello		Basınç Pressure Pression Presión Wasserdruck im Beregnen Pressione		Atış Yarı Çapı Jet Length Portée Chorro Tragweite Gittata		Su Tüketimi Capacity Débit Capacidad Kapazitätä Portata			Değerler bir Fıskiye içindir Values for a single sprinkler Données pour 1 arros. tout seul Datos para cada rociador Technische Daten für Einzelberegnen Dati relativi ad 1 irrigatore		
mm	inch	kg/cm ²	lbs/inch	m	feet	l/min	m ³ /h	G.P.M.	Sulanan Alan Irrigated area Surface arrosée Superficie irrigada Beregnete Fläche Superficie irrigata	acre	Yağış Miktarı Rainfall per hour Pluviométrie horaire Intensidad horaira Wassermenge pro Stund Intensità oraria
									m ²		mm/h
14	.47	2	29	22,0	72	195	11,7	52	1520	0,38	7,7
	.47	3	44	27,0	89	239	14,3	63	2289	0,57	6,2
	.47	4	56	30,0	98	277	16,6	73	2826	0,70	5,9
	.47	5	70	33,0	108	309	18,5	81	3419	0,84	5,4
16	.55	2	29	23,0	75	247	14,8	65	1661	0,41	8,9
	.55	3	44	29,0	95	303	18,2	80	2641	0,65	6,9
	.55	4	56	33,0	108	351	21,0	92	3419	0,84	6,1
	.55	5	70	35,0	115	391	23,4	103	3847	0,95	6,1
18	.62	2	29	22,0	72	309	18,5	81	1520	0,38	12,2
	.62	3	44	30,0	98	378	22,7	100	2826	0,70	8,0
	.62	4	56	33,0	108	436	26,2	115	3419	0,84	7,7
	.62	5	70	36,0	118	487	29,2	129	4069	1,01	7,2
20	.70	3	44	31,0	102	376	22,5	99	3018	0,75	7,5
	.70	4	56	35,0	115	460	27,6	122	3847	0,95	7,2
	.70	5	70	39,0	128	532	31,9	140	4776	1,18	6,7

ENG

Highly efficient sprinkler rotating in full circle or partial circle, impact-type, operating at medium pressure (2.0 – 5 atm) Thanks to replaceable sprinkler ends and adjustable water breaker, it ensures you to irrigate your field with uniform water distribution. It is appropriate to use for dust control at roadsides, mines, construction sites and coal depots. Main body and scoop is aluminium with lower rotating mechanism made of brass, Teflon and stainless steel. It is equipped with a system allowing use of standard stationary breaker or licenced moving breaker. Moving breaker breaks water without preventing it to reach long distances. Thanks to the setting mechanism on the breaker, water may be broken less or more. With the blind plug that comes with it as standard, the second hole for irrigation of short distances can be plugged. And this allows less water consumption.

ESP

Cabezal de aspersión de alto rendimiento con capacidad de rotación de giro completo o en el rango de ajustes de ángulo deseado, de tipo impacto y de presión media (2,0 - 5 atm). Proporciona un riego óptimo con mínimo cantidad de agua y con una distribución homogénea del agua gracias a las boquillas de aspersor intercambiables y el doble orificio de salida de agua. Apto para el riego de todo tipo de cultivos de campo y verduras. Apto para uso en sistemas fijos y móviles. Apto para uso en el control del polvo en las obras de construcción, los depósitos de carbón, las minas y en los bordes de las carreteras. El cuerpo principal y la cuchara son de aluminio y el mecanismo giratorio inferior se compone de teflón, latón y acero inoxidable. Dispone de un sistema que permite el uso de un rompedor fijo o un rompedor móvil patentado. El rompedor móvil rompe el agua sin impedir que alcance a largas

Yüziak® Sprinklers

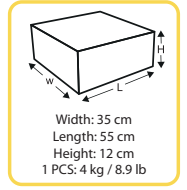
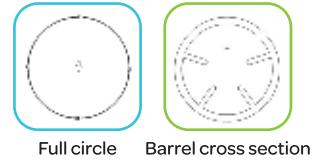

Water Input / El agua de entrada: 2"
Working Pressure / Presión de trabajo
2 – 5 kg/cm²
Water Requirement / Requerimientos de agua
11 m³/h – 46 m³/h
Nozzles / Boquilla
12mm – 14mm – 16mm – 18mm – 20mm – 22mm
Body Angle / Cuerpo Ángulo: 28°

Meme Çapı Nozzle diameter Diamètre de la bluse Diámetro de la tobera Durchmesser der Hauptdüse Diametro ugello		Basınç Pressure Pression Presión Wasserdruck im Beregner Pressione		Atış Yarı Çapı Jet Length Portée Chorro Tragweite Gittata		Su Tüketimi Capacity Débit Capacidad Kapazität Portata			Değerler bir Fıskiye içindir Values for a single sprinkler Données pour 1 arros. tout seul Datos para cada rociador Technische Daten für Einzelberegner Dati relativi ad 1 irrigatore		
									Sulanan Alan Irrigated area Surface arrosée Superficie irrigada Beregnete Fläche Superficie Irrigata		Yağış Miktarı per hour Pluviométrie horaire Intensidad horaria Wassermenge pro Stund Intensità oraria
mm	Inch	kg/cm ²	lbs/inch	m	feet	l/min	m ³ /h	G.P.M.	m ²	acre	mm/h
12	.47	2	29	24	79	183	11	48	1809	0,45	6,1
	.47	3	44	29	95	225	13,5	59	2641	0,65	5,1
	.47	4	56	31	102	258	15,5	68	3018	0,75	5,1
14	.55	3	56	30	98	283	17	75	2826	0,70	6,0
	.55	4	70	31	102	325	19,5	86	3018	0,75	6,5
	.55	5	85	35	115	367	22	97	3847	0,95	5,7
16	.62	3	56	32	105	350	21	92	3215	0,79	6,5
	.62	4	70	35	115	400	24	106	3847	0,95	6,2
	.62	5	85	38	125	450	27	119	4534	1,12	6,0
18	.70	3	85	33	108	433	26	114	3419	0,84	7,6
	.70	4	85	36	118	508	30,5	134	4069	1,01	7,5
	.70	5	85	40	131	567	34	150	5024	1,24	6,8
20	.78	3	85	35	115	500	30	132	3847	0,95	7,8
	.78	4	85	39	128	608	36,5	161	4776	1,18	7,6
	.78	5	85	43	141	667	40	176	5806	1,43	6,9
22	.86	4	85	40	131	683	41	181	5024	1,24	8,2
	.86	5	85	44	144	767	46	203	6079	1,50	7,6

ENG An impact sprinkler that rotates in a full circle. It has double-hole outlet and rotating nozzle is replaceable. It is used for full turn only. It operates at medium and high pressure (2 – 5 bar). With adjustable water breaker, it allows uniform irrigation. And thanks to body angle of 28 degrees, it is less affected by wind compared to its equivalents of 30 and 33 degrees. Main body is aluminium with rotating mechanism of lower body made of aluminium and brass. Latent type sealing system, it serves with sandy water without any problem.

ESP Cabezal de aspersión de tipo impacto con capacidad de rotación de giro completo. Cuenta con una salida con dos orificios y la boquilla rotativa es intercambiable. Apto para utilizar solo en giro completo. Capacidad de funcionamiento en presión media y alta (2-6 bares). Proporciona un riego uniforme gracias a su rompedor de agua ajustable. Se ve menos afectado del viento respecto a los modelos similares de 30 y 33 grados gracias al ángulo de cuerpo de 28 grados. El cuerpo principal es de aluminio. El mecanismo giratorio inferior se compone de aluminio y latón. Capacidad de funcionamiento en aguas arenosas gracias a su sistema de sellado de tipo oculto.

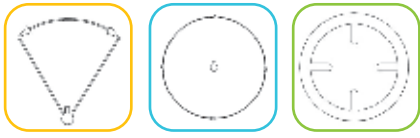

Part circle and Full circle Barrel cross section

Main Nozzles

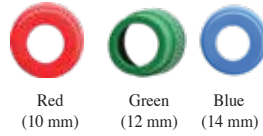

Red (10 mm) Green (12 mm) Blue (14 mm)

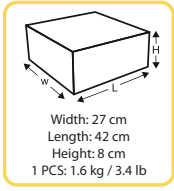

Water Input / El agua de entrada: 1,5 "
Working Pressure / Presión de trabajo
1,5 – 5 kg/cm²
Water Requirement / Requerimientos de agua
6,5 m³/h – 18 m³/h
Nozzles / Boquilla
10mm – 12mm – 14mm
Body Angle / Cuerpo Ángulo: 28°

Meme Çapı Nozzle diameter Diamètre de la bluse Diámetro de la tobera Durchmesser der Hauptdüse Diámetro ugello		Basınç Pressure Pression Presión Wasserdruck im Beregnern Pressione		Atış Yarı Çapı Jet Length Portée Chorro Tragweite Gittata		Su Tüketimi Capacity Débit Capacidad Kapazität Portata			Değerler bir Fıskiye için dir Values for a single sprinkler Données pour 1 arros. tout seul Datos para cada rociador Technische Daten für Einzelberegner Dati relativi ad 1 irrigatore			
									Sulanan Alan Irrigated area Surface arrosée Superficie irrigada Beregnete Fläche Superficie irrigata		Yağış Miktarı Rainfall per hour Pluviométrie horaire Intensidad horaira Wassermenge pro Stund Intensità oraria	
mm	inch	kg/cm ²	lbs/inch	m	feet	l/min	m ³ /h	G.P.M.	m ²	acre	mm/h	
10	.39	2,00	29	19	62	108	6,5	29	1134	0,28	5,7	
	.39	3,00	44	21	69	130	7,8	34	1385	0,34	5,6	
	.39	4,00	56	23	75	152	9,1	40	1661	0,41	5,5	
	.39	5,00	70	23,5	77	236	10,5	46	1734	0,43	6,1	
12	.47	2,00	29	21,0	69	152	9,0	40	1385	0,34	6,5	
	.47	3,00	44	23,0	75	182	11,2	49	1661	0,41	6,7	
	.47	4,00	56	25,5	84	211	13,0	57	2042	0,50	6,4	
14	.47	5,00	70	26,5	87	236	14,2	63	2205	0,54	6,4	
	.55	2,00	29	22,0	72	195	12,0	53	1520	0,38	7,9	
	.55	3,00	44	23,5	77	239	14,1	62	1734	0,43	8,1	
	.55	4,00	56	27,0	89	277	16,5	73	2289	0,57	7,2	
	.55	5,00	70	28,0	92	309	18,8	83	2462	0,61	7,6	

ENG

Highly efficient sprinkler rotating in full circle or partial circle, impact-type, operating at medium pressure (2.0 – 5 atm) Thanks to replaceable sprinkler ends and adjustable water breaker, it ensures you to irrigate your field with uniform water distribution. It is appropriate to use for dust control at roadsides, mines, construction sites and coal depots. Main body and scoop is aluminium with lower rotating mechanism made of brass, Teflon and stainless steel. It is equipped with a system allowing use of standard stationary breaker or licenced moving breaker. Moving breaker breaks water without preventing it to reach long distances. Thanks to the setting mechanism on the breaker, water may be broken less or more. With the blind plug that comes with it as standard, the second hole for irrigation of short distances can be plugged. And this allows less water consumption.

ESP

Cabezal de aspersión de alto rendimiento con capacidad de rotación de giro completo o en el rango de ajustes de ángulo deseado, de tipo impacto y de presión media (2,0 - 5 atm). Proporciona un riego óptimo con mínima cantidad de agua y con una distribución homogénea del agua gracias a las boquillas de aspersor intercambiables y el doble orificio de salida de agua. Apto para el riego de todo tipo de cultivos de campo y verduras. Apto para uso en sistemas fijos y móviles. Apto para uso en el control del polvo en las obras de construcción, los depósitos de carbón, las minas y en los bordes de las carreteras. El cuerpo principal y la cuchara son de aluminio y el mecanismo giratorio inferior se compone de teflón, latón y acero inoxidable. Dispone de un sistema que permite el uso de un rompedor fijo o un rompedor móvil patentado. El rompedor móvil rompe el agua sin impedir que alcance a largas distancias. Gracias al mecanismo de ajuste del rompedor, el agua puede romperse más o menos. Gracias a su tapón ciego que cierra el segundo orificio de salida de agua, proporciona riego en distancias cortas. De esta manera, funciona con menos cantidad de agua.

Yüzüak® Sprinklers



Main Nozzles



Part circle and Full circle Barrel cross section

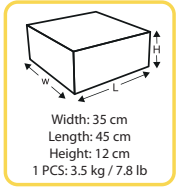

Water Input / El agua de entrada: 2"
Working Pressure / Presión de trabajo
2 – 5 kg/cm²
Water Requirement / Requerimientos de agua
11 m³/h – 32 m³/h
Nozzles / Boquilla
14mm – 16mm – 18mm – 20mm
Body Angle / Cuerpo Ángulo: 24°

Meme Çapı Nozzle diameter Diamètre de la bluse Diámetro de la tobera Durchmesser der Hauptdüse Diámetro ugello		Basınç Pressure Pression Presión Wasserdruck im Beregnen Pressione		Atış Yarı Çapı Jet Length Portée Chorro Tragweite Gittata		Su Tüketimi Capacity Débit Capacidad Kapazität Portata			Değerler bir Fiskiye içindir Values for a single sprinkler Données pour 1 arros. tout seul Datos para cada rociador Technische Daten für Einzelberegne Dati relativi ad 1 irrigatore		
mm	inch	kg/cm ²	lbs/inch	m	feet	l/min	m ³ /h	G.P.M.	Sulanan Alan Irrigated area Surface arrosée Superficie irrigada Beregnete Fläche Superficie irrigata		Yağış Miktarı Rainfall per hour Pluviométrie horaire Intensidad horaira Wassermenge pro Stund Intensità oraria
									m ²	acre	mm/h
14	.47	2	29	22,0	72	195	11,7	52	1520	0,38	7,7
	.47	3	44	27,0	89	239	14,3	63	2289	0,57	6,2
	.47	4	56	30,0	98	277	16,6	73	2826	0,70	5,9
	.47	5	70	33,0	108	309	18,5	81	3419	0,84	5,4
16	.55	2	29	23,0	75	247	14,8	65	1661	0,41	8,9
	.55	3	44	29,0	95	303	18,2	80	2641	0,65	6,9
	.55	4	56	33,0	108	351	21,0	92	3419	0,84	6,1
18	.55	5	70	35,0	115	391	23,4	103	3847	0,95	6,1
	.62	2	29	22,0	72	309	18,5	81	1520	0,38	12,2
	.62	3	44	30,0	98	378	22,7	100	2826	0,70	8,0
	.62	4	56	33,0	108	436	26,2	115	3419	0,84	7,7
20	.62	5	70	36,0	118	487	29,2	129	4069	1,01	7,2
	.70	3	44	31,0	102	376	22,5	99	3018	0,75	7,5
	.70	4	56	35,0	115	460	27,6	122	3847	0,95	7,2
	.70	5	70	39,0	128	532	31,9	140	4776	1,18	6,7

ENG

Highly efficient sprinkler rotating in full circle or partial circle, impact-type, operating at medium pressure (2.0 – 5 atm) Thanks to replaceable sprinkler ends and adjustable water breaker, it ensures you to irrigate your field with uniform water distribution. It is appropriate to use for dust control at roadsides, mines, construction sites and coal depots. Main body and scoop is aluminium with lower rotating mechanism made of brass, Teflon and stainless steel. It is equipped with a system allowing use of standard stationary breaker or licenced moving breaker. Moving breaker breaks water without preventing it to reach long distances. Thanks to the setting mechanism on the breaker, water may be broken less or more. With the blind plug that comes with it as standard, the second hole for irrigation of short distances can be plugged. And this allows less water consumption.

ESP

Cabezal de aspersión de alto rendimiento con capacidad de rotación de giro completo o en el rango de ajustes de ángulo deseado, de tipo impacto y de presión media (2,0 - 5 atm). Proporciona un riego óptimo con mínimo cantidad de agua y con una distribución homogénea del agua gracias a las boquillas de aspersor intercambiables y el doble orificio de salida de agua. Apto para el riego de todo tipo de cultivos de campo y verduras. Apto para uso en sistemas fijos y móviles. Apto para uso en el control del polvo en las obras de construcción, los depósitos de carbón, las minas y en los bordes de las carreteras. El cuerpo principal y la cuchara son de aluminio y el mecanismo giratorio inferior se compone de teflón, latón y acero inoxidable. Dispone de un sistema que permite el uso de un rompedor fijo o un rompedor móvil patentado. El rompedor móvil rompe el agua sin impedir que alcance a largas distancias. Gracias al mecanismo de ajuste del rompedor, el agua puede romperse más o menos. Gracias a su tapón ciego que cierra el segundo orificio de salida de agua, proporciona riego en distancias cortas. De esta manera, funciona con menos cantidad de agua.

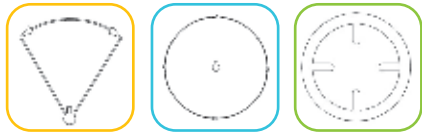

Part circle and Full circle Barrel cross section

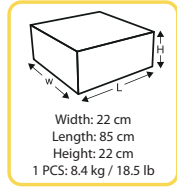

Yüzziak®
Sprinklers



Water Input / El agua de entrada: 2"
Working Pressure / Presión de trabajo
3 – 7 kg/cm²
Water Requirement / Requerimientos de agua
23 m³/h – 76 m³/h
Nozzles / Boquilla
18mm – 20mm – 22mm – 24mm – 26mm – 28mm
Body Angle / Cuerpo Ángulo: 27°

Meme Çapı Nozzle diameter Diamètre de la bluse Díametro de la tobera Durchmesser der Hauptdüse Díametro ugello		Basiç Pressure Pression Presión Wasserdruck im Beregnen Pressione		Atış Yarı Çapı Jet Length Portée Chorro Tragweite Gittata		Su Tüketimi Capacity Débit Capacidad Kapazität Portata			Değerler bir Fıskiye içindir Values for a single sprinkler Données pour 1 arros. tout seul Datos para cada rociador Technische Daten für Einzelberegne Dati relativi ad 1 irrigatore			
									Sulanan Alan Irrigated area Surface arrosée Superficie irrigada Beregnete Fläche Superficie irrigata		Yağış Miktarı Rainfall per hour Pluviométrie horaire Intensidad horaira Wassermenge pro Stund Intensità oraria	
mm	inch	kg/cm ²	lbs/inch	m	feet	l/min	m ³ /h	G.P.M.	m ²	acre	mm/h	
18	0,7	3	44	32	105	390	23,4	103	3215	0,79	7,3	
	0,7	4	56	35	115	445	26,7	118	3847	0,95	6,9	
	0,7	5	70	37	121	498,33	29,9	132	4299	1,06	7,0	
	0,7	6	85	39	128	553,33	33,2	146	4776	1,18	7,0	
20	0,78	3	44	35	115	463,33	27,8	122	3847	0,95	7,2	
	0,78	4	56	38	125	548,33	32,9	145	4534	1,12	7,3	
	0,78	5	70	42	138	616,67	37	163	5539	1,37	6,7	
	0,78	6	85	43	141	666,67	40	176	5806	1,43	6,9	
22	0,86	4	56	40	131	680	40,8	180	5024	1,24	8,1	
	0,86	5	70	44	144	753,33	45,2	199	6079	1,50	7,4	
	0,86	6	85	47	154	818,33	49,1	216	6936	1,71	7,1	
	0,94	5	70	43	141	816,67	49	216	5806	1,43	8,4	
24	0,94	6	85	45	148	900	54	238	6359	1,57	8,5	
	0,94	7	100	46	151	933,33	56	247	6644	1,64	8,4	
	1,02	4	56	43	141	883,3	53	233	5806	1,43	9,1	
26	1,02	5	70	45	148	950,0	57	251	6359	1,57	9,0	
	1,02	6	85	48	157	1050,0	63	277	7235	1,79	8,7	
	1,1	5	70	47	154	1083,3	65	286	6936	1,71	9,4	
28	1,1	6	85	50	164	1200,0	72	317	7850	1,94	9,2	
	1,1	7	100	53	174	1266,7	76	335	8820	2,18	8,6	

ENG A sprinkler version which is able to rotate in a full-circle or in the range of angle settings you make when required, operating at medium pressure. With its replaceable nozzles and moving water-breaking system, it enables you to irrigate your field with an excellent and uniform water distribution. It rotates full circle and semi-circle at same speed. It is suitable for any use, agricultural or industrial. It has single-hole nozzle of new type. As it is, it operates with less water, minimizing problem of nozzle-clogging arising from waste water. It has special paint of new type and it is much more durable against environmental factors thanks to new type powder paint. With its single-hole nozzle construction, adjustable moving water-breaker and body of 27°, this version is also conveniently used for any kind of agricultural application, discharge of waste water in the industry; evaporation of lakes and swamps and for dust suppression and similar industrial applications. Thanks to non-clogging nozzle section, it is very appropriate for use on travelling irrigators.

ESP Cabezal de aspersión de alto rendimiento con capacidad de rotación de giro completo o en el rango de ajustes de ángulo deseado, equipado con transmisión y de presión media. Proporciona un riego óptimo con una distribución homogénea del agua gracias a las boquillas de aspersor intercambiables y el sistema móvil de ruptura del agua. Capacidad de rotación de círculo completo y semicírculo a la misma velocidad. Apto para todo tipo de usos agrícolas e industriales. Cuenta con una boquilla nueva de un solo orificio. De esta manera, se logra que funcione con menos cantidad de agua y así como se reduce al mínimo el problema de la obstrucción de la boquilla. Cuenta con una nueva pintura especial. Gracias a su pintura nueva en polvo, es más resistente a los factores ambientales. Apto para uso en todo tipo de aplicaciones agrícolas e industriales tales como la eliminación de las aguas residuales en la industria, la evaporación de lagos y pantanos, control del polvo, etc. gracias a su cuerpo con ángulo de 27°, la estructura de boquilla con una sola salida y el rompedor de agua ajustable. Apto para uso en máquinas de riego móviles gracias al perfil de la boquilla anti obstrucción.

Yüziak® Sprinklers

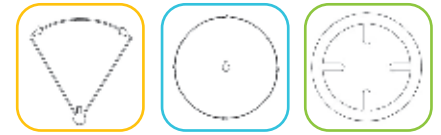

Part circle and Full circle Barrel cross section

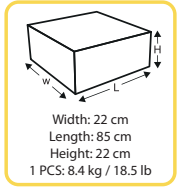

Width: 22 cm
Length: 85 cm
Height: 22 cm
1 PCS: 8.4 kg / 18.5 lb



Water Input / El agua de entrada: 2 "
Working Pressure / Presión de trabajo
3 – 7 kg/cm²
Water Requirement / Requerimientos de agua
15 m³/h – 58 m³/h
Nozzles / Boquilla
14mm – 16mm – 18mm – 20mm – 22mm – 24mm
Body Angle / Cuerpo Ángulo: 43°

Meme Çapı Nozzle diameter Diamètre de la bluse Diámetro de la tobera Durchmesser der Hauptdüse Diametro ugello		Pressure Pression Presión Wasserdruck im Beregner Pressione		Jet Length Portée Chorro Tragweite Gittata		Capacity Débit Capacidad Kapazität Portata					H Maximum Height Hauteur maximale Altura máxima maximale Höhe Altezza massima		DH Distance at the soil from sprinkler to apogee Distance au stop entre canon et apogée Distancia al suelo entre aspersor y apogeo Bodensabstand zwischen regner und erdferne	
mm	inch	kg/cm ²	lbs/inch	m	feet	l/min	m ³ /h	G.P.M.	m	feet	Metre	feet		
14	.55	3	44	27.5	90	250	15	66	9.5	31	16	52		
	.55	4	56	30.5	100	287	17.2	76	11.5	38	18	59		
	.55	5	70	32.5	107	322	19.3	85	13.5	44	20	66		
	.55	6	85	34	112	343	20.6	91	14.5	48	22	72		
16	.62	3	44	30.5	100	313	18.8	83	10.5	34	17	56		
	.62	4	56	33.5	110	358	21.5	95	12.5	41	19	62		
	.62	5	70	35	115	403	24.2	107	14.0	46	21	69		
	.62	6	85	37.5	123	425	25.5	112	16.0	52	24	79		
18	.70	4	56	35.5	116	467	28	123	13.0	43	21	69		
	.70	5	70	37.5	123	493	29.6	130	15.0	49	23	75		
	.70	6	85	40	131	543	32.6	144	17.0	56	25	82		
	.78	3	44	33.5	110	462	27.7	122	11.0	36	21	69		
20	.78	4	56	37	121	553	33.2	146	13.5	44	22	72		
	.78	5	70	39.5	130	608	36.5	161	15.5	51	24	79		
	.78	6	85	42	138	632	37.9	167	16.5	54	27	89		
	.86	3	44	35	115	573	34.4	151	11.0	36	22	72		
22	.86	4	56	38.5	126	658	39.5	174	13.5	44	24	79		
	.86	5	70	41	134	733	44	194	16.0	52	26	85		
	.86	6	85	43	141	767	46	203	18.0	59	28	92		
	.94	4	56	39	128	788	47.3	208	14.0	46	26	85		
24	.94	5	70	41.5	136	818	49.1	216	16.5	54	29	95		
	.94	6	85	45	148	902	54.1	238	18.5	61	31	102		
	.94	7	100	47	154	967	58	255	21.0	69	33	108		

ENG It wets and damps wide range of areas with minimum water consumption thanks to its special construction. With its transmission, it allows spread of water drops over the working site in a cloud of mist. It has equal rotation speed, forward and backward. With its stainless rotating bearings coated with special powder paint, Dustjet is protected against mild and medium degree chemical waters.

ESP Capacidad de humectación e hidratación de áreas amplias con una mínima cantidad de agua gracias a su estructura especial. Gracias a su estructura con transmisión, proporciona que las gotas de agua se distribuyen sobre el área de trabajo como una niebla. Dispone de una velocidad de rotación igual hacia adelante y hacia atrás. Dustjet está protegido contra aguas químicas leves y moderadas gracias a los cojinetes de rotación anti oxidables y chapados con la pintura especial en polvo.

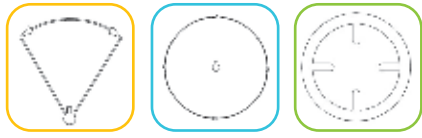

Part circle and Full circle Barrel cross section

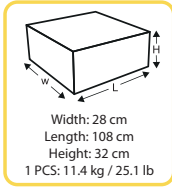

Yüzziak®
Sprinklers



Water Input / El agua de entrada : Flange 130mm x 78mm
 Working Pressure / Presión de trabajo
 3 – 7 kg/cm²
 Water Requirement / Requerimientos de agua
 41 m³/h – 108 m³/h
 Nozzles / Boquilla
 24mm – 26mm – 28mm – 30mm – 32mm
 Body Angle / Cuerpo Ángulo: 43°

Meme Çapı Nozzle diameter Diamètre de la bluse Diámetro de la tobera Durchmesser der Hauptdüse Diametro ugello		Basınç Pressure Pression Presión Wasserdruck im Beregner Pressione		Atış Yarı Çapı Jet Length Portée Chorro Tragweite Gittata		Su Tüketimi Capacity Débit Capacidad Kapazität Portata						
									H Maximum Height Hauteur maximale Altura máxima maximale Höhe Altezza massima		DH Distance at the soil from sprinkler to apogee Distance au stop entre canon et apogée Distancia al suelo entre aspersor y apogeo Bodensabstand zwischen regner und erdferne	
mm	inch	kg/cm ²	lbs/inch	m	feet	l/min	m ³ /h	G.P.M.	m	feet	Metre	feet
24	0,95	3	44	38	125	683	41	181	12,0	39	22	72
	0,95	4	56	40	131	800	48	211	14,0	46	25	82
	0,95	5	70	42	138	917	55	242	16,0	52	27	89
	0,95	6	85	44	144	983	59	260	18,0	59	30	98
26	1,03	3	44	37	121	800	48	211	13,0	43	23	75
	1,03	4	56	42	138	933	56	247	15,0	49	27	89
	1,03	5	70	45	148	1050	63	277	17,0	56	28	92
	1,03	6	85	48	157	1133	68	299	18,0	59	30	98
28	1,1	3	44	38	125	933	56	247	18,0	59	24	79
	1,1	4	56	44	144	1083	65	286	16,0	52	27	89
	1,1	5	70	47	154	1200	72	317	17,0	56	29	95
	1,1	6	85	50	164	1300	78	343	19,0	62	31	102
30	1,18	4	56	46	151	1200	72	317	16,0	52	27	89
	1,18	5	70	49	161	1350	81	357	18,0	59	30	98
	1,18	6	85	52	171	1483	89	392	19,0	62	32	105
32	1,25	4	56	47	154	1333	80	352	17,0	56	28	92
	1,25	5	70	50	164	1533	92	405	19,0	62	31	102
	1,25	6	85	53	174	1667	100	440	21,0	69	33	108
	1,25	7	100	55	180	1800	108	476	22,5	74	35	115

ENG It wets and damps wide range of areas with minimum water consumption thanks to its special construction. With its transmission, it allows spread of water drops over the working site in a cloud of mist. It has equal rotation speed, forward and backward. With its stainless rotating bearings coated with special powder paint, Dustjet is protected against mild and medium degree chemical waters.

ESP Capacidad de humectación e hidratación de áreas amplias con una mínima cantidad de agua gracias a su estructura especial. Gracias a su estructura con transmisión, proporciona que las gotas de agua se distribuyen sobre el área de trabajo como una niebla. Dispone de una velocidad de rotación igual hacia adelante y hacia atrás. Dustjet está protegido contra aguas químicas leves y moderadas gracias a los cojinetes de rotación anti oxidables y chapados con la pintura especial en polvo.



Part circle and Full circle Barrel cross section

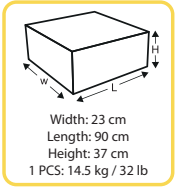

Water Input / El agua de entrada: Flange 145mm x 78mm
 Working Pressure / Presión de trabajo
 4 – 8 kg/cm²
 Water Requirement / Requerimientos de agua
 70 m³/h – 150 m³/h
 Nozzles / Boquilla
 30mm – 32mm – 34mm – 36mm
 Body Angle / Cuerpo Ángulo: 23°

Meme Çapı Nozzle diameter Diámetro de la bluse Durchmesser der Hauptdüse Diámetro ugello	Basınç Pressure Pression Presión Wasserdruck im Beregner Pressione			Atış Yarı Çapı Jet Length Portée Chorro Tragweite Gittata		Su Tüketimi Capacity Débit Capacidad Kapazität Portata			Değerler bir Fiskiye içindir Values for a single sprinkler Données pour 1 arros. tout seul Datos para cada rociador Technische Daten für Einzelberegne Dati relativi ad 1 irrigatore		
	inch	kg/cm ²	lbs/inch	m	feet	l/min	m ³ /h	G.P.M.	m ²	acre	mm/h
30	1,18	4	56	52	171	1220	73,2	322	8491	2,10	8,6
	1,18	5	70	55	180	1383	83	365	9499	2,35	8,7
	1,18	6	85	60	197	1488	89,3	393	11304	2,79	7,9
32	1,25	4	56	54	177	1383	83	365	9156	2,26	9,1
	1,25	5	70	58	190	1550	93	409	10563	2,61	8,8
	1,25	6	85	63	207	1733	104	458	12463	3,08	8,3
34	1,25	7	100	66	216	1850	111	489	13678	3,38	8,1
	1,33	5	70	59	194	1750	105	462	10930	2,70	9,6
	1,33	6	85	63	207	1950	117	515	12463	3,08	9,4
36	1,33	7	100	68	223	2033	122	537	14519	3,59	8,4
	1,42	6	85	66	216	2117	127	559	13678	3,38	9,3
	1,42	7	100	70	230	2253	135	595	15386	3,80	8,8
	1,42	8	114	74	243	2435	146	643	17195	4,25	8,5

ENG Highly efficient sprinkler rotating in full circle or partial circle, impact-type, operating at high pressure (4 – 8 atm). It rotates full circle and semi-circle at same speed. It is the biggest and versatile version among range of our products. It is mostly used for any kind of irrigation and damping operations for washing and damping. And it is also used for industrial applications such as dust suppression, fire protection, evaporation and wetting.

ESP Cabezal de aspersión de alto rendimiento con capacidad de rotación de giro completo o en el rango de ajustes de ángulo deseado, equipado con transmisión y de presión alta (4-8 atm). Capacidad de rotación de círculo completo y semicírculo a la misma velocidad. Es una pistola muy versátil y es la más grande de nuestra gama. Se utiliza con mucha frecuencia en todo tipo de procesos de riego e hidratación para hidratar y limpiar. Apto para usos en aplicaciones industriales tales como el control del polvo, la protección contra incendios, la evaporación y la humectación.

Yüzziak® Sprinklers



MINI ECO STAND 1''

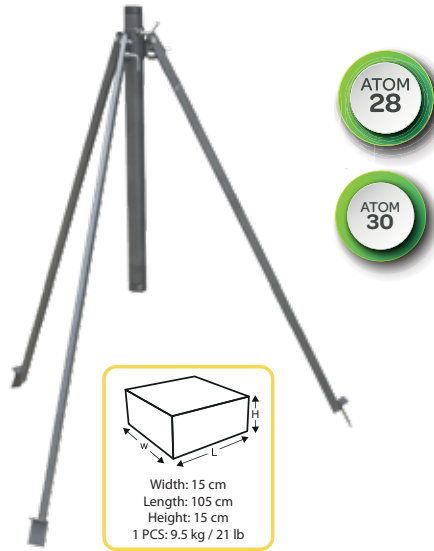

PRO ECO STAND 1,5''



PRO ECO 4POD STAND 1,5''

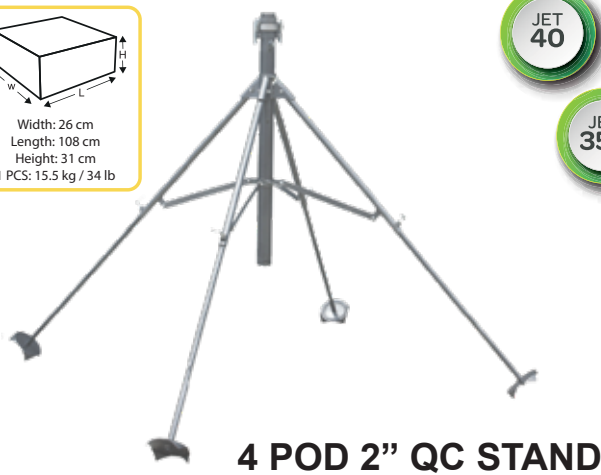
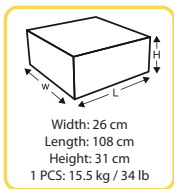

4 POD 2'' QC STAND

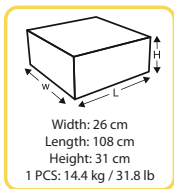

4 POD 2'' ECO STAND

yüziak[®]

Sprinklers

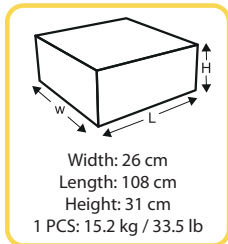

4 POD 2,5'' ECO STAND

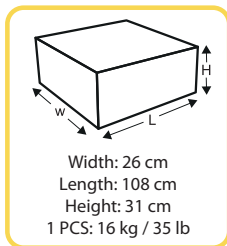

4 POD 3'' ECO STAND

**SLIDE BASE SPRINKLER CHARD 3/4"
ATOM 15 PC LF**

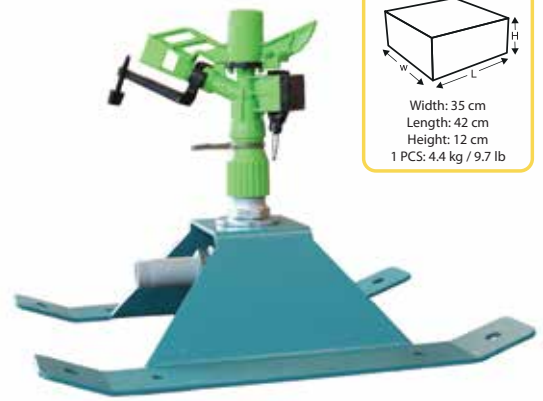

Width: 35 cm
Length: 42 cm
Height: 12 cm
1 PCS: 4.4 kg / 9.7 lb

Width: 22 cm
Length: 75 cm
Height: 12.5 cm
1 PCS: 5.5 kg / 12.1 lb



WHEELED RAINGUN CARD 1"

Width: 26 cm
Length: 108 cm
Height: 31 cm
1 PCS: 14.3 kg / 31.5 lb



WHEELED RAINGUN CARD 1,5"

Width: 26 cm
Length: 108 cm
Height: 31 cm
1 PCS: 21.5 kg / 47.3 lb



WHEELED RAINGUN CARD 2"

Width: 60 cm
Length: 120 cm
Height: 27 cm
1 PCS: 40 kg / 50 lb



**WHEELED RAINGUN CARD 2"
WITH HOSE REEL**

Yüzüak® Sprinklers



**Quick Coupling System For 1"
NPT Or BSP Connection With Stop Valve**

Available Size:

- Inlet 1" BSP or NPT Male Screw X Output Ø32 - B Part With Stop Valve
- Inlet 1" BSP or NPT Male Screw X Output Ø32 Male - A Part
- 1" Quick Coupling System Set (B Part + A Part)



SUCTION QUICK COUPLING SET

Available Size:

- Suction Quick Pump Side 76 mm Male BSP Or NPT Screw-Hose Side 76 mm Male with 2 pcs Clamp
- Suction Quick Pump Side 110 mm BSP Or NPT Male Screw-Hose Side 101 mm Male with 2 pcs Clamp
- Suction Quick Pump Side 125 mm BSP Or NPT Male Screw-Hose Side 125 mm Male with 2 pcs Clamp



**1" Air Release Valve
(NPT Or BSP)**



**2" Air Release Valve
(NPT Or BSP)**



**Hydrant (NPT Or BSP)
Available Size: 2.5" - 3" - 4"**



**2"x2" quick Coupling (NPT or BSP)
2"x1.5" quick Coupling (NPT or BSP)**



Movable Layflat Irrigation System

Aluminium Quick Coupler and HDPE Elbow , TE and Blind Plug

Sistema de irrigación móvil Layflat

Acople rápido de aluminio y codo HDPE, TE y tapón ciego



Aluminium couplers suitable for 52mm -76mm and 90mm Layflats

HDPE Parts Suitable for 63mm , 76mm and 90mm Connectors

For more information please contact with us

Acoples de aluminio adecuados para 52mm -76mm y 90mm Layflats

Piezas de HDPE adecuadas para conectores de 63 mm, 76 mm y 90 mm

Para mayor más información, póngase en contacto con nosotros



Agronema
agriculture and industrial supplies



ISO 9001:2015